



User Manual

**UTG2000B Series**  
**Function/Arbitrary Waveform Generator**

**2011.09.**

**UNI-T Technologies, Inc.**



# Preface

Dear Users:

Hello! Thank you for choosing this brand new Uni-Trend device. In order to use this instrument safely and correctly, please read this manual thoroughly, especially the Safety Notes part.

After reading this manual, it is recommended to keep the manual at an easily accessible place, preferably close to the device, for future reference.

# Copyright Information

UNI-T is Uni-Trend Technology (China)Co., Limited. All rights reserved.

UNI-T products are protected by patent rights in China and other countries, including issued and pending patents.

Uni-Trend reserves the rights to any product specification and pricing changes.

Uni-Trend reserves all rights. Licensed software products are properties of Uni-Trend and its subsidiaries or suppliers, which are protected by national copyright laws and international treaty provisions. Information in this manual supersedes all previously published versions.

UNI-T is the registered trademark of Uni-Trend Technology (China)Co., Limited.

Uni-Trend warrants that this product will be free from defects for a three-year period. If the product is re- sold, the warranty period will be from the date of the original purchase from an authorized UNI-T

distributor. Probes, other accessories, and fuses are not included in this warranty.

If the product is proved to be defective within the warranty period, Uni-Trend reserves the rights to either repair the defective product without charging any parts or labor, or exchange the defected product to a working equivalent product. Replacement parts and products may be brand new, or perform at the same specifications as brand new products. All replacement parts, modules, and products are the property of Uni-Trend.

The "customer" refers to the individual or entity that is declared in the guarantee. In order to obtain the warranty service, "customer" must inform the defects within the applicable warranty period to UNI-T, and to perform appropriate arrangements for the warranty service. The customer shall be responsible for packing and shipping the defective products to the designated maintenance center of UNI-T, pay the shipping cost, and provide a copy of the purchase receipt of the original purchaser . If the product is shipped domestically to the location of the UNI-T service center, UNI-T shall pay the return shipping fee. If the product is sent to any other location, the customer shall be responsible for all shipping, duties, taxes, and any other expenses.

This warranty shall not apply to any defects or damages caused by accidental, machine parts' wear and tear, improper use, and improper or lack of maintenance. UNI-T under the provisions of this warranty has no obligation to provide the following services:

- a) Repair any damage caused by the installation, repair, or maintenance of the product by non UNI-T service representatives.
- b) Repair any damage caused by improper use or connection to an incompatible device.
- c) Repair any damage or malfunction caused by the use of a power source which does not conform to the requirements of this manual.
- d) Any maintenance on altered or integrated products (if such alteration or integration leads to an increase in time or difficulty of product maintenance).

---

This warranty written by UNI-T for this product, and it is used to substitute any other expressed or

---

implied warranties. UNI-T and its distributors do not offer any implied warranties for merchantability or applicability purposes.

For violation of this guarantee, UNI-T is responsible for the repair or replacement of defective products is the only remedy available to customers. Regardless of whether UNI-T and its distributors are informed that any indirect, special, incidental, or consequential damage may occur, the UNI-T and its distributors shall not be responsible for any of the damages.

# Introduction

This device is economical, high-performance, multi-functional single channel waveform generators. It uses direct digital synthesis (DDS) technology to produce accurate and stable waveforms. It can generate accurate, stable, pure and low distortion output signals; also can provide high-frequency vertical edge square waves. UTG2000B's convenient interface, superior technical indexes and user-friendly graphical display style can help users to complete tasks quickly and improve work efficiency.

## Main Features

- Dual-channel with independent output mode
- Sampling rate of 1.28GSa/s and vertical resolution of 16bit
- Sine wave output of 120MHz/80MHz/60MHz, full-band resolution of 1 $\mu$ Hz
- Square wave of 30MHz/25MHz/25MHz, minimum margin time can reach to 11ns and its rising, falling, and duty ratio time are adjustable
- Pulse waveform of 30MHz/25MHz/25MHz, adjustable time of rising, falling and duty ratio 2~16 independent harmonic waves in phase position
- Support 18 expressions of function, maximum length:160 characters
- Arbitrary wave storage of 8~16M points, 200 groups non-volatile waveform storage
- Storage up to 20MB (.bsv or.csv) or 7GB(optional)
- Rich modulation types: AM、FM、PM、ASK、FSK、PSK、BPSK、QPSK、OSK、SUM、DSBAM、QAM、PWM
- Support frequency scanning and burst output
- Dual channel can respectively or simultaneously: internal/external modulation, internal/external/manual trigger
- Compatible 7 digits TTL level signal
- 4.3 inches TFT color screen with USB Host(max.32G), USB Device, LAN, 10MHz clock source input, 10MHz clock source output
- Powerful upper computer software
- Easy-to-use multi-functional knob and numeric keypad

# Table of Contents

Preface.....	3
Copyright Information.....	2
Introduction .....	4
Table of Contents .....	5
Chapter 1 Safety Information.....	7
1.1 Safety Terms and Symbols.....	7
1.2 General Safety Overview.....	7
Chapter 2 Quick Start .....	9
2.1 General Inspection .....	9
2.1.1 Check for Damages Caused by Transport.....	9
2.1.2 Check Accessories .....	9
2.1.3 Machine Inspection.....	9
2.2 Handle Adjustment.....	9
2.3 Panels and Buttons.....	10
2.3.1 Front Panel .....	10
2.3.2 Rear Panel.....	11
2.3.3 Function Interface .....	11
2.4 Basic Waveform Output .....	12
2.4.1 Set output frequency .....	12
2.4.2 Set output amplitude .....	13
2.4.3 Set DC offset voltage .....	13
2.4.4 Set square wave .....	14
2.4.5 Set pulse wave.....	14
2.4.6 Set DC offset voltage .....	15
2.4.7 Set ramp wave.....	15
2.4.8 Set noise wave.....	16
2.4.9 Set harmonic Wave .....	16
2.4.10 Set expression .....	17
2.5 Set utility .....	19
2.5.1 Set channel.....	19
2.5.2 Channel coupling.....	21
2.5.3 Frequency meter .....	22
2.5.4 Network.....	22
2.5.5 System .....	23
Chapter 3 Advanced Applications .....	26
3.1 Generate Modulation Waveform .....	26
3.1.1 Amplitude Modulation (AM).....	26
3.1.2 Frequency Modulation (FM).....	32
3.1.3 Phase Modulation (PM).....	39
3.1.4 Amplitude Shift Keying (ASK).....	46
3.1.5 Frequency Shift Keying (FSK) .....	51
3.1.6 Phase Shift Keying (PSK) .....	56
3.1.7 Binary Phase Shift Keying (BPSK).....	62

3.1.8 Quadrature Phase Shift Keying(QPSK) .....	67
3.1.9 Oscillation Keying(OSK) .....	68
3.1.10 Sum Modulation(SUM) .....	72
3.1.11 Double side band amplitude Modulation (DSBAM) .....	77
3.1.12 Quadrature Amplitude Modulation(QAM) .....	81
3.1.13 Pulse Width Modulation (PWM).....	85
3.2 Output Frequency Sweep Waveform.....	91
3.2.1 Select Frequency Sweep Start frequency sweep .....	91
3.2.2 Set Starting and Stop Frequency.....	92
3.2.3 Frequency Sweep Mode .....	93
3.2.4 Frequency Sweep Time .....	94
3.2.5 Select Trigger Source.....	94
3.2.6 Trigger Output.....	95
3.2.7 Trigger Edge .....	96
3.2.8 Comprehensive Example .....	96
3.3 Output Burst .....	99
3.3.1 Select Burst .....	99
3.3.2 Type of Burst .....	101
3.3.3 Gating mode .....	102
3.3.4 Phase of Burst .....	103
3.3.5 Period of Burst .....	103
3.3.6 Counting of Burst .....	104
3.3.7 Select Trigger Source.....	104
3.3.8 Trigger Output.....	104
3.3.9 Trigger Edge .....	105
3.4 Output Arbitrary Wave .....	108
3.4.1 Use Arbitrary Wave Function .....	108
3.4.2 Point-by-point Output/Play Mode .....	109
3.4.3 Select Arbitrary Wave .....	110
3.4.4 Create and Edit Arbitrary Waveform.....	114
Chapter 4 Fault Handling .....	115
4.1 No Display on Screen (Blank Screen) .....	115
4.2 No Waveform Output .....	115
4.3 Fail to Correctly Recognize U Disk.....	115
Chapter 5 Service and Support .....	116
5.1 Program Upgrade of Product .....	116
5.2 Outline of Warranty .....	116
5.3 Contact Us.....	116
Appendix A: Factory Reset State .....	117
Appendix B: Performance Index .....	120
Appendix C: List of Accessories .....	125
Appendix D: Maintenance and Cleaning .....	126

# Chapter 1 Safety Information

## 1.1 Safety Terms and Symbols

The following terms may appear in this manual:

Warning: The conditions and behaviors may endanger life.

Note: The conditions and behaviors may cause damage to the product and other properties. The following terms may appear on the product:

Danger: This operation may cause immediate damage to the operator. Warning: This operation may cause potential damage to the operator.

Note: This operation may cause damage to the product and devices connected to the product. The following symbols may appear on the product:

 Alternating Current

 Ground Terminal for Testing

 Ground Terminal for Chassis

 On/Off Button

 High Voltage

 Caution

 Protective Ground Terminal

 CE marking

 CSA International

 N10149 Spectrum Management Agency of Australia

 Environmental Protection Use Period (EPUP)

1SM1-A: This instrument belongs to SM Group1 Class A according to CISPR Article 4 ICES/NMB-001: This instrument complies with ICES-001

## 1.2 General Safety Overview

This instrument strictly complies with the GB4793 safety requirements for electrical equipment and EN61010-1/2 safety standard during design and manufacturing. It complies with the safety standards for over voltage CAT II and pollution level II.

If the equipment is used in a manner not specified by the manufacturer, the protection provided by

the equipment may be impaired.

Please read the following safety preventative measures:

To avoid electric shock and fire, please use the dedicated UNI-T power supply appointed to the local region or country for this product.

This product is grounded through the power supply ground wire. To avoid electric shock, grounding conductors must be connected to the ground. Please be sure that the product is properly grounded before connecting to the input or output of the product.

To avoid personal injury and prevent damaging the product, only trained personnel can perform the maintenance program.

To avoid fire or electric shock, please notice rated operating range and product marks. Do not use the product outside the rated range.

Please check the accessories for any mechanical damage before usage. Only use accessories that came with this product.

Please do not put metal objects into the input and output terminals of this product.

Do not operate the product if you suspect it is faulty, and please contact UNI-T authorized service personnel for inspection.

Please do not operate the product when the instrument box opens. Please do not operate the product in humid conditions.

Please keep the product surface clean and dry.

---

# Chapter 2 Quick Start

## 2.1 General Inspection

It is recommended to follow the steps below to check the instrument before using this device for the first time.

### 2.1.1 Check for Damages Caused by Transport

If the packaging carton or the foam plastic cushions are severely damaged, please contact the UNI-T distributor of this product immediately.

If the instrument is damaged by transport, please keep the package and contact the transport department and the UNI-T distributor, the distributor will arrange for repair or replacement.

### 2.1.2 Check Accessories

- Power cord-----1PCS
- USB data cable-----1PCS
- BNC cable (1 meter)-----1PCS
- BNC+red and black alligator clip connection cable(1 meter)---1PCS
- User CD-----1PCS
- User manual-----1PCS
- Warranty-----1PCS

If any of the accessories are missing or damaged, please contact UNI-T or local distributors of this product.

### 2.1.3 Machine Inspection

If the instrument appears to be damaged, not working properly, or has failed the functionality test, please contact UNI-T or local distributors of this product.

## 2.2 Handle Adjustment

UTG2000B series handle can be adjusted freely. If the handle position needs to be changed, please hold the

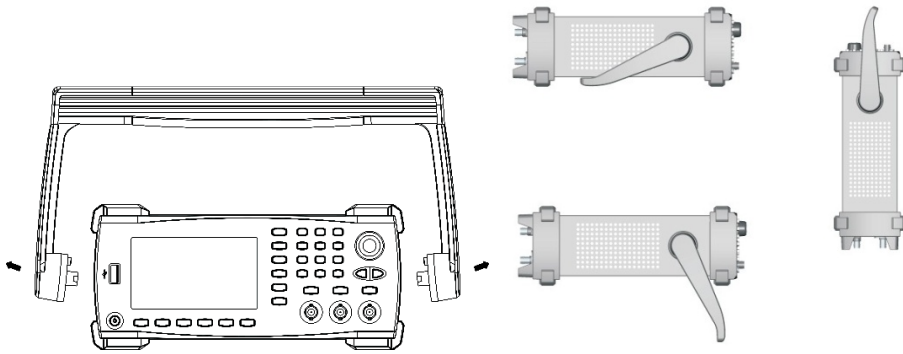

## 2.3 Panels and Buttons

### 2.3.1 Front Panel

UTG2000B series provides users with a simple, intuitive, and easy to operate front panel. The front panel is shown in figure 2-1:

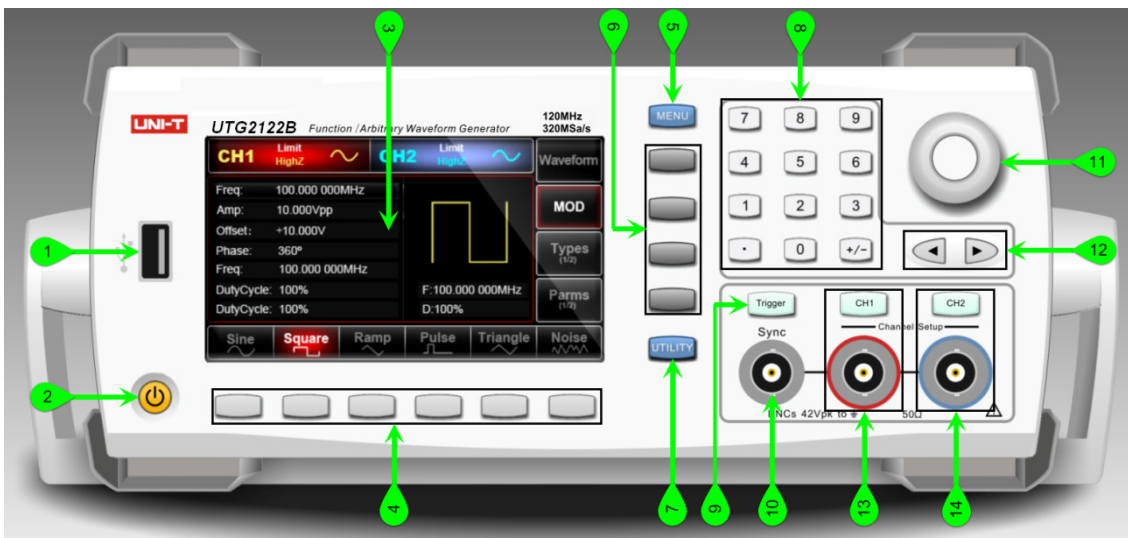

1. USB port
2. ON/OFF
3. Display Screen
4. Main Menu Button
5. Secondary Menu Button
6. Utility and setting
7. Number buttons
8. Manual trigger
9. Sync output terminal
10. Functional knob
11. Arrow button
12. CH1 output terminal
13. CH2 output terminal

Note: there is over voltage protection for each output terminal in case of the following condition:

- Setting amplitude  $>100\text{mVpp}$ , input voltage  $>\pm 12.0\text{V}$ , frequency  $<10\text{ kHz}$ .
- Setting amplitude  $\leq 100\text{mVpp}$ , input voltage  $>\pm 2.0\text{V}$ , frequency  $<10\text{ kHz}$ . “Overload protection, output off” appears when the protection is valid.

### 2.3.2 Rear Panel

The rear panel is shown in figure 2-2:

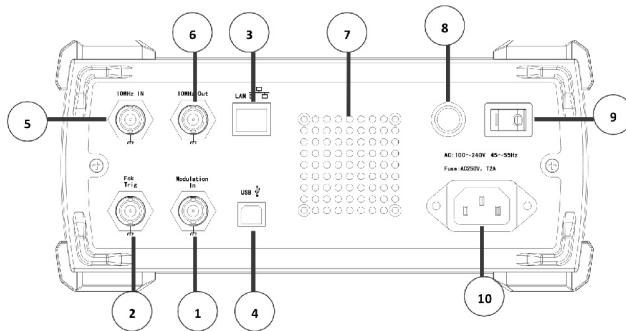



1. External analog modulation input connector
2. External digital modulation/ frequency meter connector
3. LAN port
4. USB port
5. External 10MHz input connector
6. Internal 10MHz output connector
7. Ventilation vent
8. Fuse
9. Power switch
10. AC power supply

### 2.3.3 Function Interface

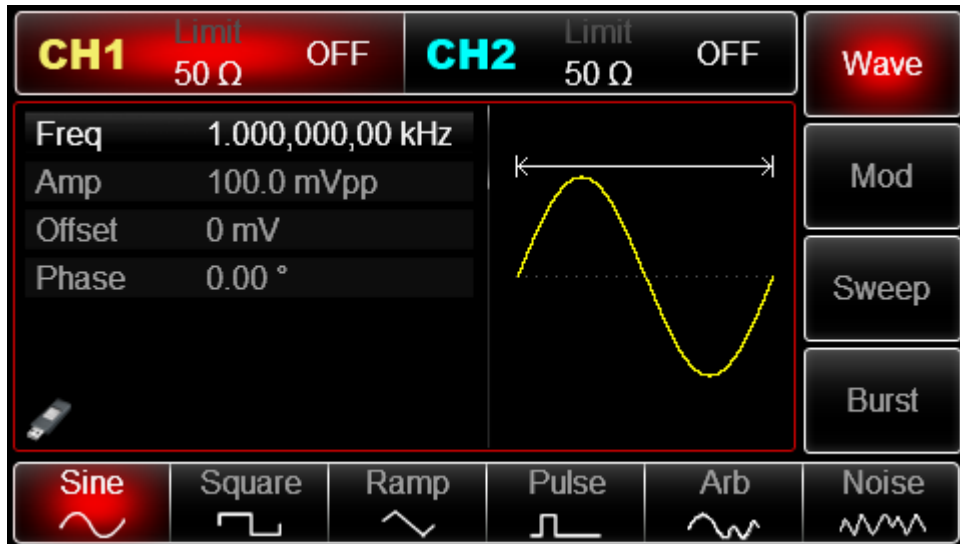
Function interface is shown in figure 2-3:



**Description:**

- CH1/CH2: the selected channel will be highlighted.
  - 1) Limit indicates output range is at limit. White color: valid; Grey color: invalid.
  - 2) 50Ω indicates the matched impedance of output terminal (1Ω to 10KΩ adjustable, or high resistance; default:50Ω)
  - 3) : sine wave. Different modes have different menu.
  - Bezel menu on the right: corresponding buttons for different function. Highlighted display indicates that the function is selected.
  - Bezel menu on the bottom: sub menu belonging to the right menu. Highlighted display indicates that the function is selected.
- If the submenu has over 6 labels, use  button to flip over.
- 1) Labels on the right of screen: Highlighted display indicates that the label is selected. If not, press corresponding soft key to select.
  - 2) Labels at the bottom of screen: Sub label belongs to the next category of Type label. Press corresponding button to select sub labels.

## 2.4 Basic Waveform Output

This chapter introduces how to output different waveforms. Default waveform: sine wave with 1 kHz and 100mVpp.

### 2.4.1 Set output frequency

Default waveform: A sine wave of 1 kHz frequency and 100mV amplitude (with 50Ω termination).

Steps for setting the frequency to 2.5MHz:

- 1) Press **[Menu]** → **[Wave]** → **[Param]** → **[Freq]** in turn to set the frequency. Pressing Freq to edit frequency or period.
- 2) Press the number keyboard to input 2.5.
- 3) Select corresponding unit on the bottom bezel menu: MHz

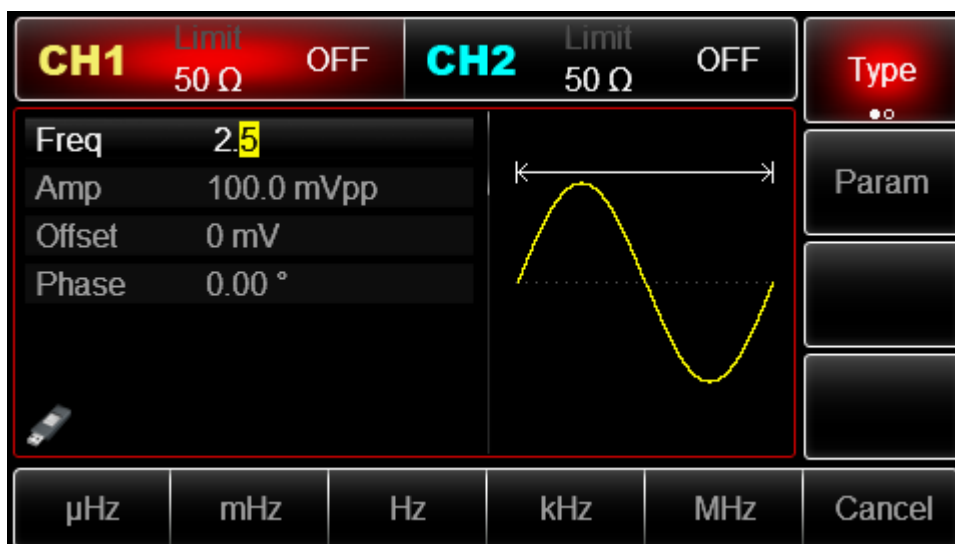

## 2.4.2 Set output amplitude

Default waveform: A sine wave of 100mV peak-peak value with 50Ω termination. Steps for setting the amplitude to 300mV:

1. Press **Menu** → **Wave** → **Param** → **Amp** in turn. Press Vpp, Vrms, and dBm.
2. Press number button to input 300.
3. Press unit mVpp.

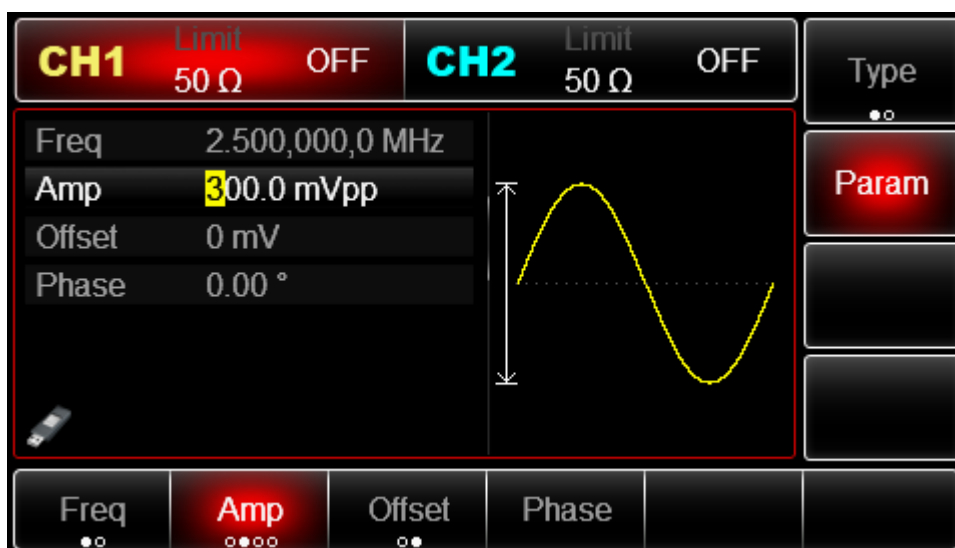

## 2.4.3 Set DC offset voltage

Default waveform: sine wave with 0V DC offset voltage (with 50Ω termination). Steps for setting DC offset voltage to -150mV:

1. Press **Menu** → **Wave** → **Param** → **Offset**
2. Use number keys to input the required number of -150.
3. Select corresponding unit mV.

Note: if the current DC offset value is valid, use this value. Press offset again, the parameters

become high level (MAX) and low level (MIN).

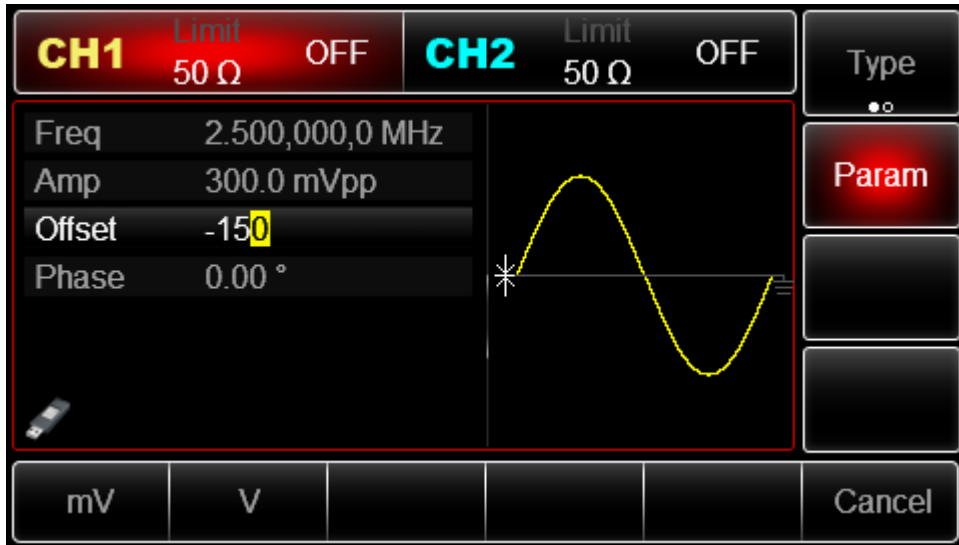

### 2.4.4 Set square wave

Default duty ratio: 50% limited by minimum pulse width 6.5ns. Steps to set a square wave with 1Hz, 1.5Vpp, DC offset 0V, duty ratio 70%:

1. Press **Menu** → **Wave** → **Type** → **Square** → **Param**
2. Enter required numerical value and select the unit.

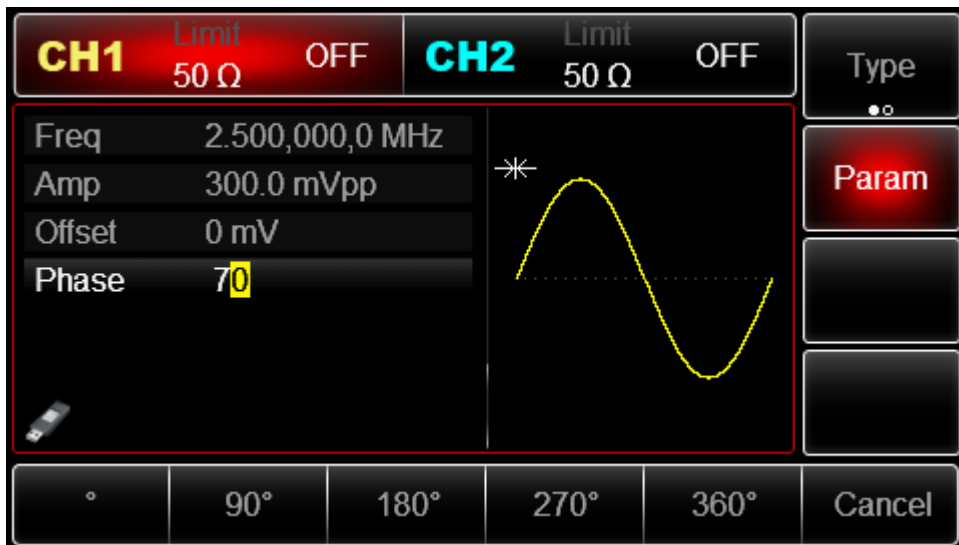

### 2.4.5 Set pulse wave

Example: period=2ms, amplitude=1.5Vpp, offset=0V, duty=25%, rising time=200us and falling time=200us:

1. Press **Menu** → **Wave** → **Type** → **Pulse** → **Param**, and then press Freq to switch to Period. Enter required number value and select the unit. When entering duty ratio value, there is a label at the bottom of display, and select 25%.
2. Press Param to enter sub menu to set falling edge time, then press Fall to enter required

number and select unit.

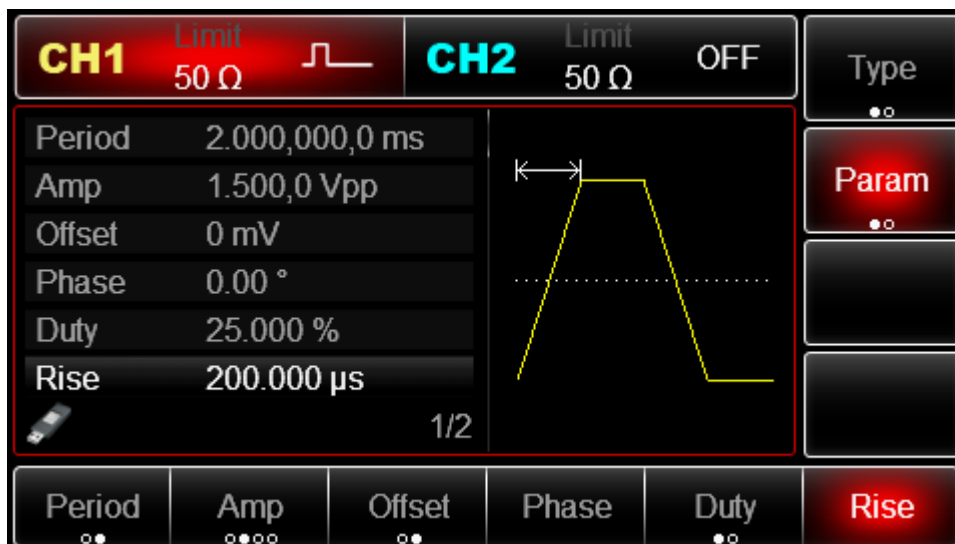

Note: This parameter can be set by multifunctional knob and direction buttons.

## 2.4.6 Set DC offset voltage

Default DC voltage: 0V.

Steps for setting DC offset voltage to 3V:

1. Press **Menu** → **Wave** → **Type** → **DC**. If the current DC voltage is valid, adapt the same DC voltage value.
2. Enter 3.
3. Select required unit V

Note: This parameter can be set by multifunctional knob and direction buttons.



## 2.4.7 Set ramp wave

Default symmetry degree of ramp wave: 100%.

Steps for setting a ramp wave with 10 kHz frequency, 2V amplitude, 0V DC offset and 50% duty

ratio:

1. Press **Menu** → **Wave** → **Type** → **Ramp** → **Param**
2. Select the parameter to enter edit mode, then input required numbers and select unit. Note: When enter symmetry degree value, press 50% label at the bottom of the display.

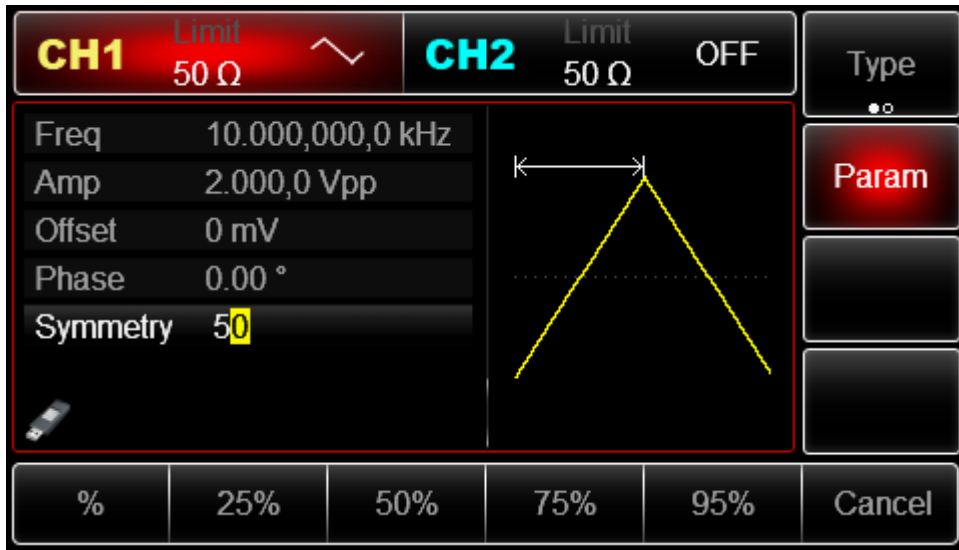

### 2.4.8 Set noise wave

Default noise: Gauss noise with amplitude 100mVpp and DC offset 0mV.

Steps for setting Quasi Gauss noise with 300mVpp amplitude and 1V DC offset:

Press **Menu** → **Wave** → **Type** → **Noise** → **Param** to enter parameter editing mode. After setting, enter number and unit.

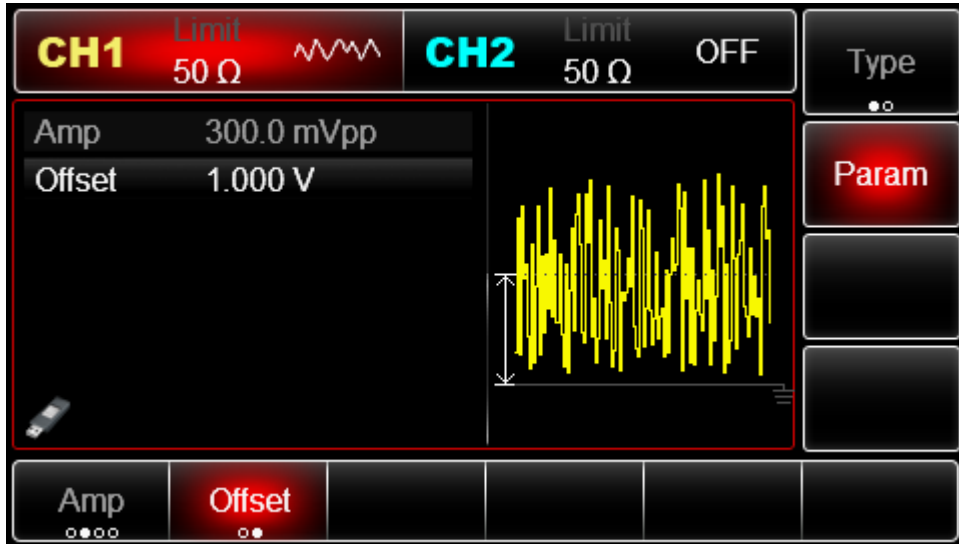

### 2.4.9 Set harmonic Wave

Default frequency:1kHz, amplitude 100mVpp, DC offset 0mV, phase position 0°,harmonic wave type is odd order, total is 2 times, current is 2 times. Amplitude 100mV, phase position 0°Steps for setting the harmonic wave type is all, wave time is 2 times, amplitude is 4Vpp, phase position is 0°:

Press **Menu** → **Wave** → **Type** → **Harmonic** → **Param** in turn to enter parameter editing mode. After setting, enter number and unit.



## 2.4.10 Set expression

Expression consists of number, operational character, class symbol (bracket), and free variables for the calculation of value, the permutation of which can represent the output waveform.

Basic expression:  $V_{out} = f(x)$ , for example:  $f(x) = (x-1) \cdot x \cdot (x+1)$ , the interface is as below:

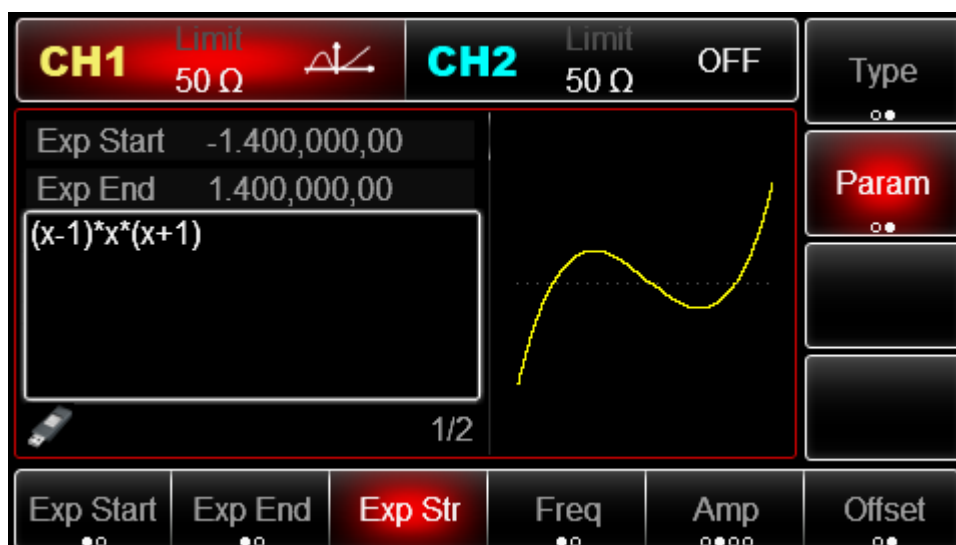

The output from the signal source is duplicate signal within limited period, therefore, it is necessary to define the range of the variable in the expression  $f(x)$ . The range of  $x$  is determined by **Initial value** and **End value**. Press **Initial value** to activate this parameter. Use the keypad to input 1.4rad, the unit can be ° or rad, the interface is as below:

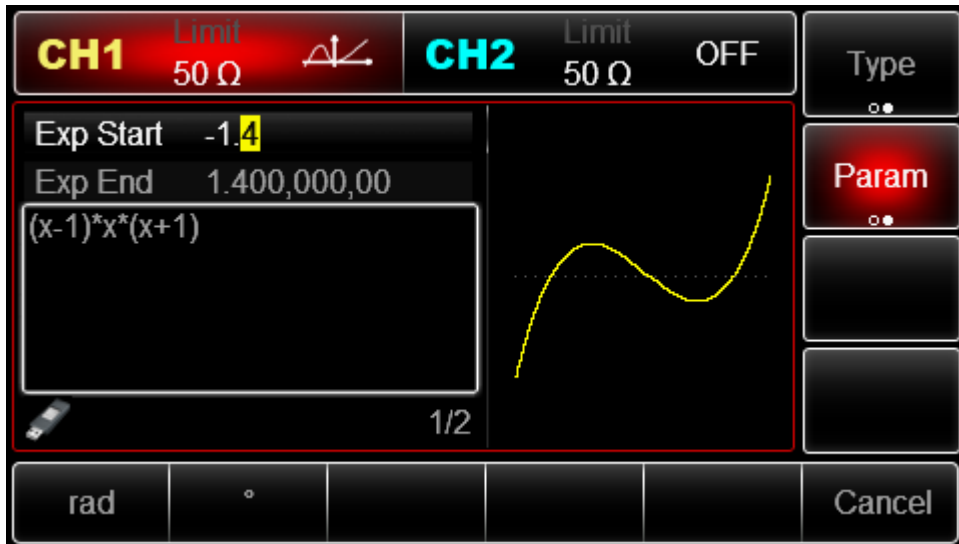

18 types of operational functions are supported in this instrument. Expression enter into the expression editing interface, press Next to cycle switch operational symbol or expression. For example, input  $(x-1)x(x+1)$ , the interface is as below:

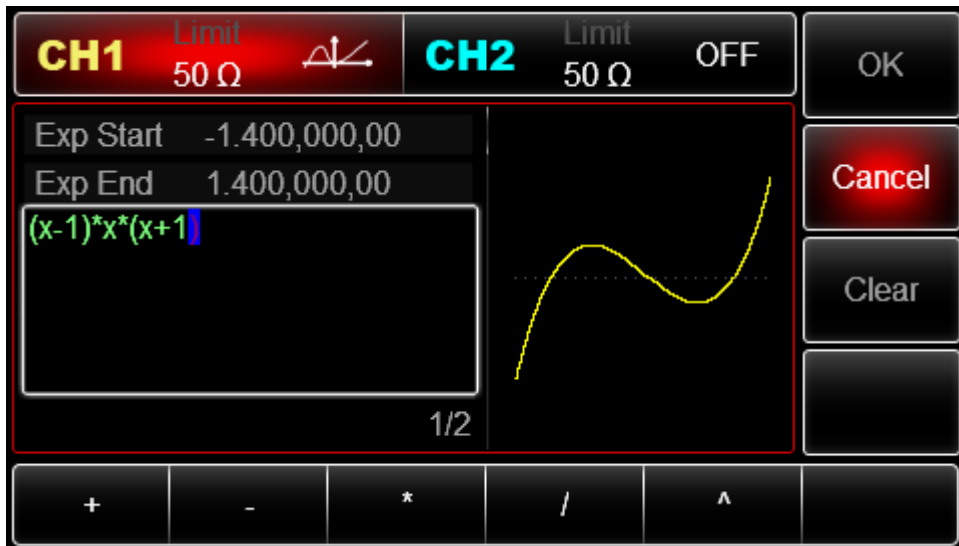

The default initial value is  $0^\circ$ , end value is  $180^\circ$ , and expression is  $\sin(x)$ . The unit can be in rad or  $^\circ$ . The setup procedures are as following:

Press **Menu** → **Waveform** → **Type** → **Expression** → **Parameter** in this order (**Type** is only accessible when it is shown in Grey), press the variable button, input value and select the unit.



## 2.5 Set utility

You can set channel information, sync output, merge channel, set up channel coupling, frequency meter, network, system, language, clock, load, save setting, arbitrary wave management, software upgrade, help, system information in Utility.

### 2.5.1 Set channel

Menu	Sub menu	Setting	Note
CH1 setting/ CH2 setting	Channel output	ON/OFF	
	Channel reverse	ON/OFF	
	Sync output	CH1/CH2/OFF	
	Load	50Ω, high resistance	1Ω to 1kΩ
	Channel merge	ON/OFF	When this function is ON, channel 1 merges with channel 2.
	Channel duplicate		Channel can be duplicated each other in settings status.
	Amplitude limit	ON/OFF	
	Amplitude upper limit		Set the upper limit of amplitude output
	Amplitude lower limit		Set the lower limit of amplitude output

Select Utility  $\Rightarrow$  CH1 setting (or CH2 setting), to set the channel :

**Note:** Since there are numerous items under CH1 setting, there are 2 pages in this menu. You need to press CH1 setting again to skip to next page. CH2 setting is the same.

1. Channel output

Select **Channel output**, you can select ON/OFF.

**Note:** you can quickly turn on the channel output by pressing the **CH1** or **CH2** on the keypad.

2. Channel reverse

Select **Channel reverse**, you can select ON/OFF.

3. Sync output

Select **Sync output**, you can select "CH1", "CH2" or "OFF".

4. Load

Select **Load**, input range: 1Ω~1kΩ, you can also select 50Ω or high resistance.

5. Channel merge

The signal source of CH1/CH2 will output CH1/CH2 waveform normally. When you turn on the channel merge function, it will output CH1+CH2 waveform. Select **Channel merge**, select ON/OFF, the interface is shown as below:

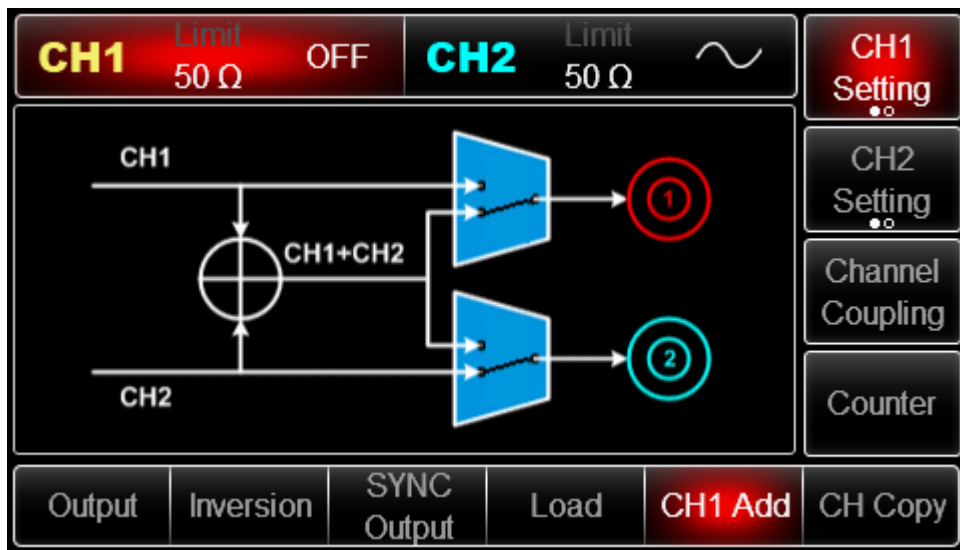

When you turn on the channel merge, and switch to other menu, there is **1/2** symbol at lower left of the screen indicating channel merge is ON.

6. Channel duplicate

Duplicate the parameter and status of one of the channel to the other.

Select **Channel duplicate**

7. Amplitude limit

Support amplitude limit to protect the load

Select **Amplitude limit**, you can select ON/OFF

## 8. Amplitude upper limit



Select **Amplitude upper limit**, to set the limit value.

## 9. Amplitude lower limit

Select **Amplitude lower limit**, to set the limit value.

## 2.5.2 Channel coupling

Menu	Sub menu	Setting	Note
Channel coupling	ON/OFF	ON/OFF	Only when the status is ON, the following menu can be opened.
	Parameter coupling	Frequency coupling, amplitude coupling, phase coupling	
	Signal tracking	Phase deviation	

**Note:** when you select parameter coupling,  appears at the lower left corner. When you select signal tracking,  appears instead.

## 1. Parameter coupling

Coupling of frequency, amplitude or phase. You can set the frequency deviation/ frequency ratio, amplitude deviation/ratio or phase deviation/ratio of these two channels. The parameters of them are the reference for each other. When you change the parameter of one channel, the parameter of the other will adjust accordingly and keep the same deviation/ratio as the reference channel.

Deviation:=CH2-CH1; Ratio=CH2: CH1

Select **Utility** → **Channel coupling**, the status is OFF, then select **Channel coupling** → **ON** → **Coupling type** → **Parameter coupling** in this order, you can set up parameter coupling: frequency, amplitude and phase

**Note:** In frequency coupling, you can select OFF, deviation or ratio.

## 2. Signal tracking

Select **Utility** → **Channel coupling**, the status is OFF, then select **Channel coupling** → **ON** → **Coupling type** → **Signal tracking** in order, set up phase deviation. When you set the deviation, and the parameter of one channel, the other one will adjust accordingly.

### 2.5.3 Frequency meter

This instrument is able to measure the frequency and duty ratio of compatible TTL electric level signal. The range of measurement frequency is 100mHz~200MHz. When using the frequency meter function, the compatible TTL electric level signal is inputted through external digital modulation or frequency meter terminal (FSK Trig/CNT connector).

You can select **Utility** then **Frequency meter** to read frequency, period and duty ratio in the list. When there is no input, the frequency meter will show the data of last measurement.

### 2.5.4 Network

Menu	Sub menu	Setting	Note
Network	Access	Auto/Manual	When you select manual, you can edit the following items
	IP address		
	Sub-net mask		
	Gateway		
	MAC address		

Select **Utility**, **Network** to enter into network setting.

*Note: Since there are numerous items in Utility, there are 2 pages, you need to press again to skip to next page.*

1. Access

Press **Access** to select Auto/Manual

2. IP address

IP address format: nnn.nnn.nnn.nnn, range of the first nnn: 1 to 223, range of the other three nnn: 0 to 255. It is suggested to ask the network administrator for an available IP address. Select **IP address**, use the keypad or the dial to input IP address. Save this setting. When starting the instrument next time, the setting will be loaded automatically.

3. Sub-net mask

4. Sub-net mask format: nnn.nnn.nnn.nnn, range nnn: 0 to 255. It is suggested to ask the network administrator for an available Sub-net mask. Select **Sub-net mask**, use the keypad or the dial to input Sub-net mask. Save this setting. When starting the instrument next time, the setting will be

loaded automatically.

#### 5. Gateway

Gateway format: nnn.nnn.nnn.nnn, range nnn: 0 to 255. It is suggested to ask the network administrator for an available Gateway. Select **Gateway**, use the keypad or the dial to input Gateway. Save this setting. When starting the instrument next time, the setting will be loaded automatically.

#### 6. MAC address

MAC address is initiated from 0, every stepping is 1. It is an unsigned integer shown in binary number.

## 2.5.5 System

Menu	Sub menu	Setting	Note
System	Language	English, simplified Chinese, traditional Chinese	
	Clock	Internal, external	
	Clock output	ON/OFF	
	Sound	ON/OFF	
	Separator	Comma, space, null	
	Backlight	10%, 30%, 50%, 70%, 90%	
	Load		You can select factory setting or save the setting
	Save		Save the setting to U disk
	Arbitrary wave management		
	Software upgrade		Insert the U disk to upgrade the software
	Help		Help document
About		Model, version, company info	

Press **Utility**, **System**, to enter into system setting:



*Note: Since there are numerous items in System, there are 2 pages, you need to press again to skip to next page.*

#### 1. Language

Set the language of the system, press **Language** and select English, simplified Chinese or traditional Chinese.

#### 2. Clock source

Press **Clock source** to select internal or external.

Internal: Provide 10MHz clock source. External: Receive external clock signal through **【10MHz In】** (Requirement: Frequency: 10MHz, amplitude is TTL electric level). If there is no detected valid external clock source, a prompt will pop up stating that “External 10MHz clock invalid” with  symbol appears at the lower left corner. If the source is valid,  will be shown instead.

### 3. Clock output

Press **Clock output** to select ON/OFF

When you turn on the clock output, **【10MHz Out】** will output clock source (Frequency is 10MHz, amplitude is TTL electric level) for other devices

### Instrument Sync Method:

4. Connect the **【10MHz Out】** of the first instrument (clock output ON) to **【10MHz In】** of the second instrument (clock source is external), set both instruments with the same output frequency. For more instrument synchronization, just connect the other instrument in cycle with the method above.

### 5. Sound

Buzzer notification, press **Sound** and select ON/OFF.

### 6. Number separator

Separator between numerical value, press **Separator** and select comma, space or null

### 7. Backlight

Set the brightness of the display, press **Backlight** and select 10%, 30%, 50%, 70%, 90%.

### 8. Load

Press **Load** to select factory setting or save setting

### 9. Save

Press **Save** to save the current setting

### 10. Arbitrary wave

Save the arbitrary wave, and save to U disk. Press **Arbitrary wave** to select Internal or External (available on U disk insertion). Select Internal and you can see arbitrary wave, select External to enter into arbitrary wave input interface.

### 11. Software upgrade

Support U disk firmware upgrade, procedures are as following:

- a. Copy and paste the \*.bin file to U disk
- b. Insert the U disk to the USB Host port, when the  symbol appears on the lower left corner of the display indicating U disk connected.
- c. Press **Software upgrade** and select upgrade file, click Confirm
- d. It takes 2 to 3 minutes to upgrade. During this process, the device will restart to validate the upgrade.

*Note: Do not power off during upgrade process!*

## 12. Help

Help system provides the help information about the keypad and the menu. You can find operational help of the front panel buttons. Long press any button to open HELP, for example Menu, press any button to exit HELP.

## 13. About

Press **About**, you will find information about this device, such as model number, version and company information, etc.

# Chapter 3 Advanced Applications

## 3.1 Generate Modulation Waveform

### 3.1.1 Amplitude Modulation (AM)

In AM modulation, modulated waveform is usually composed of carrier wave and modulation wave. The modulation of CH1 and CH2 is independent, you can set up the same or different mode for them.

Press **Menu** → **Mod** → **Type** → **AM** to enable the AM function. Then the modulated waveform will be displayed with modulation waveform and carrier wave

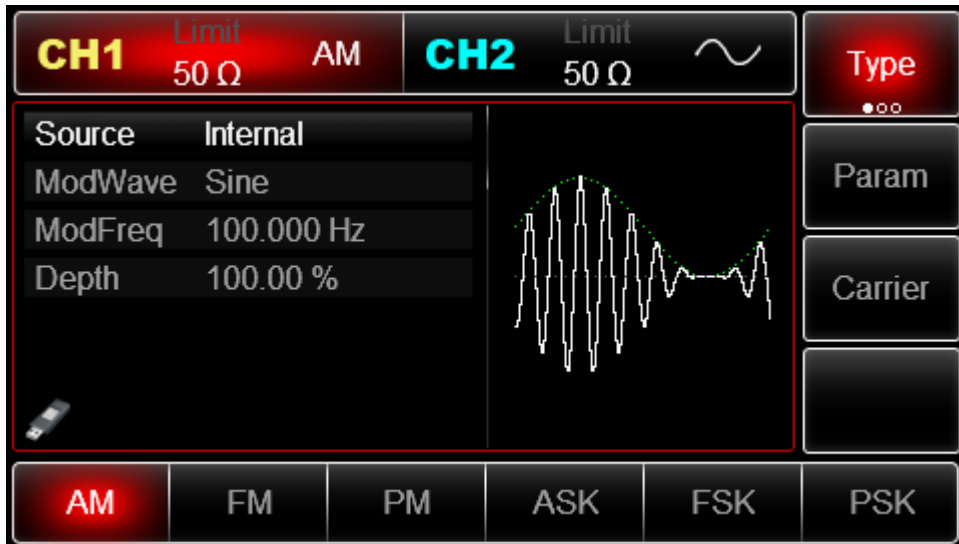

Select Carrier Waveform

Press **Carrier** to select a carrier waveform.

AM carrier waveform can be: sine(default), square, ramp or arbitrary (except DC).

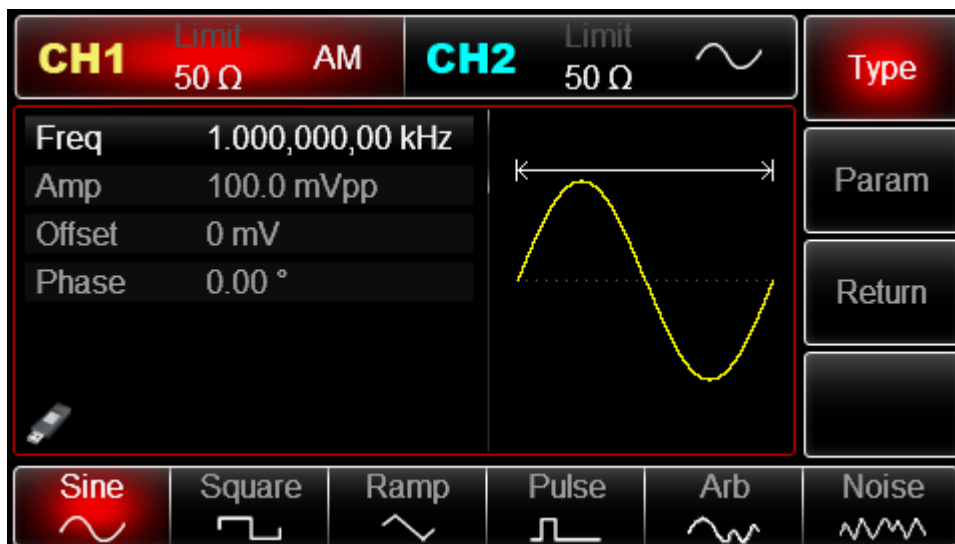

**Set Carrier Wave Frequency**

Default frequency is 1kHz. Different carrier waveform has different settable frequency range. Press **Param** → **Freq**, enter value and select the unit.

Carrier Wave	Frequency					
	UTG2122B		UTG2082B		UTG2062B	
	Minimum Value	Maximum Value	Minimum Value	Maximum Value	Minimum Value	Maximum Value
Sine wave	1μHz	120MHz	1μHz	80MHz	1μHz	60MHz
Square wave	1μHz	30MHz	1μHz	25MHz	1μHz	25MHz
Ramp wave	1μHz	5MHz	1μHz	4MHz	1μHz	3MHz
Impulse wave	1μHz	30MHz	1μHz	25MHz	1μHz	25MHz
Arbitrary wave	1μHz	25MHz	1μHz	20MHz	1μHz	15MHz

**Modulation Source Selection**

Both internal and external modulation source are compatible. After enabling AM function, the default modulation source is internal. If need to change press

**Param** → **Source** → **External**.

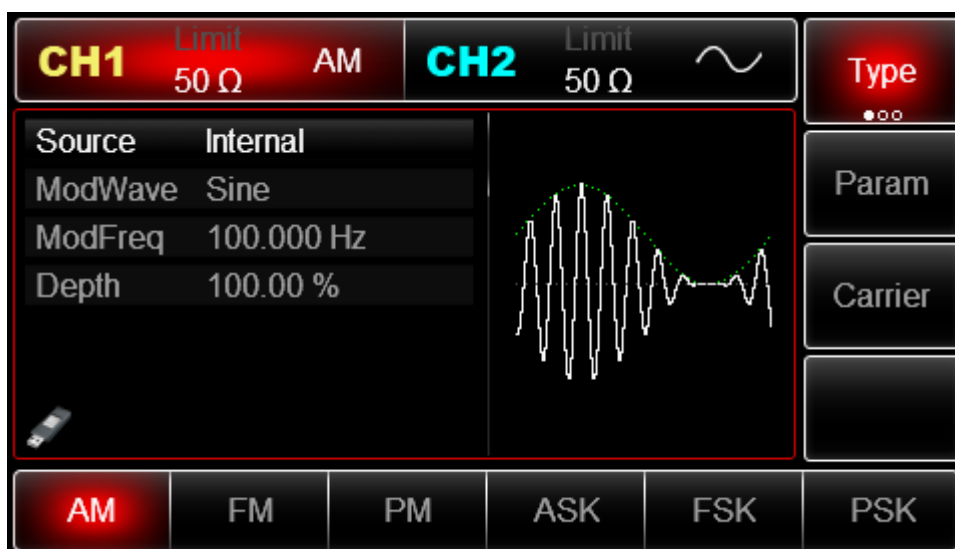

1) Internal Source

Modulation wave can be: sine wave(default), square wave, rising ramp wave, falling ramp wave,

arbitrary wave and noise. If need to change the waveform, press **Param** → **ModWave**.

- Square wave: duty ratio is 50%
- Rising Ramp Wave: symmetry degree is 100%
- Falling Ramp Wave: symmetry degree is 0%
- Arbitrary Wave: when arbitrary wave is modulated waveform, DDS function generator limits arbitrary wave length as 4kpts

## 2) External Source

When modulation source is external, parameter list will hide the modulation wave option and modulation frequency option, and carrier waveform will be modulated by an external waveform. AM modulation depth is controlled by  $\pm 5V$  signal level of external modulation input terminal (Modulation In connector). For example, if modulation depth value is set to 100%, AM output amplitude is the maximum when external modulation signal is +5V, AM output amplitude is the minimum when external modulation signal is -5V.

## Set Modulation Wave Frequency

When modulation source is internal, frequency can be reset. Default of modulation wave frequency is 100Hz. Press **Param** → **Mod** Freq to change. Modulation frequency range: 2 MHz~1MHz. When modulation source is external, parameter list will hide the modulation wave option and modulation frequency option, and carrier waveform will be modulated by an external waveform. The range of external signal frequency is 0Hz~ 20 kHz.

## Set Modulation Depth

Modulation depth indicates the extent of amplitude variation which is expressed as percentage. Settable range of AM modulation depth is 0% ~ 120%, and the default is 100%. When modulation depth is set to 0%, the constant amplitude (half of the carrier wave amplitude) is output. Output amplitude changes as modulation waveform changes when modulation depth is set to 100%. The instrument output a peak-peak voltage less than  $\pm 5V$  (50 $\Omega$  terminal) when modulation depth is more than 100%.

If need to change, press **Param** → **Depth** in amplitude function interface. When modulation source is external, output amplitude of the instrument is controlled by  $\pm 5V$  signal level of external modulation input terminal (Modulation In connector) in rear panel. For example, if modulation depth value in parameter list has been set to 100%, AM output amplitude is the maximum when external modulation signal is +5V, AM output amplitude is the minimum when external modulation signal is -5V.

## Comprehensive Example

Set a sine wave with 200Hz from the internal of the instrument as a modulation signal and a square wave: frequency =10 kHz, amplitude of 200mVpp and duty ratio of 45% as a carrier wave signal. Finally, set modulation depth to 80%. Specific steps are seen as following: Noise: White Gauss noise

## 3) Enable Amplitude Modulation (AM) Function

Press **Menu** → **Mod** → **Type** → **AM** in turn.

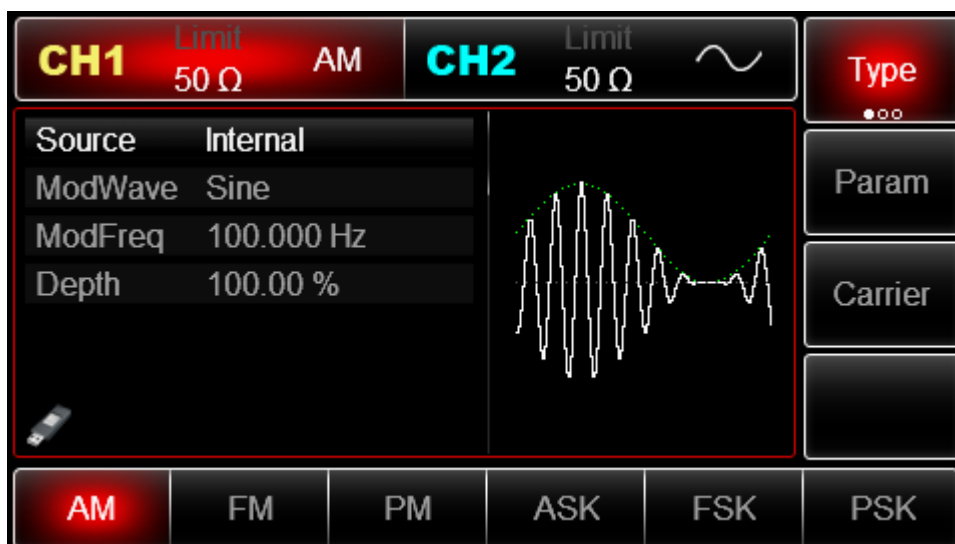

Set Modulation Signal Parameter

After enabling the AM function, press Param soft key and the interface will appear as following:

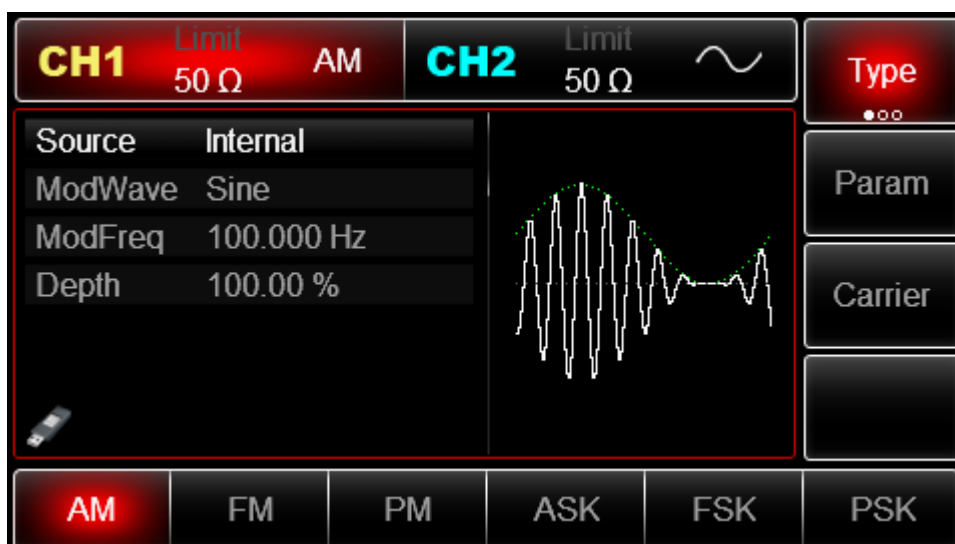

Press corresponding soft key, then enter required numerical value, and select the unit.

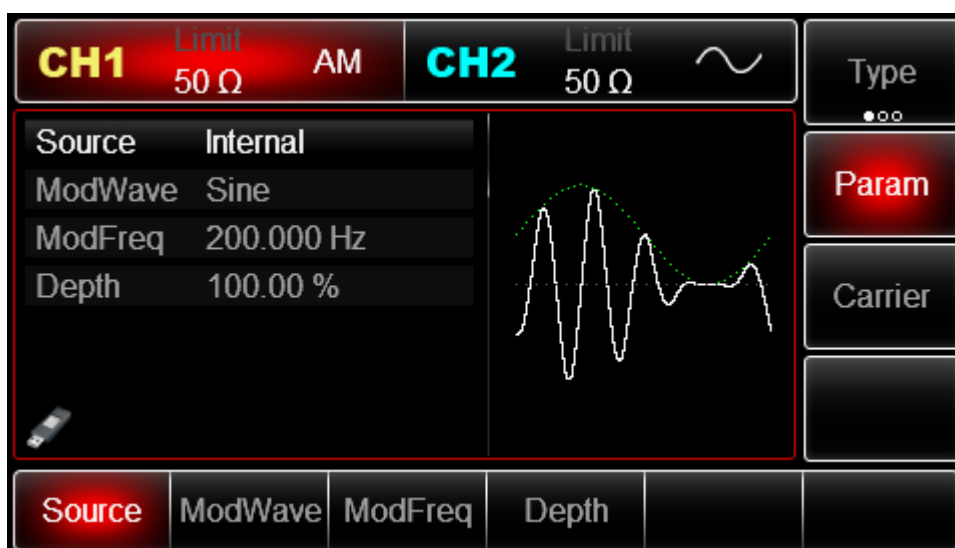

Set Carrier Wave Signal Parameter

Press **Carrier** → **Type** → **Square** in turn to select square wave as carrier wave signal.



Press **Param** soft key again, and the interface will pop up as following:

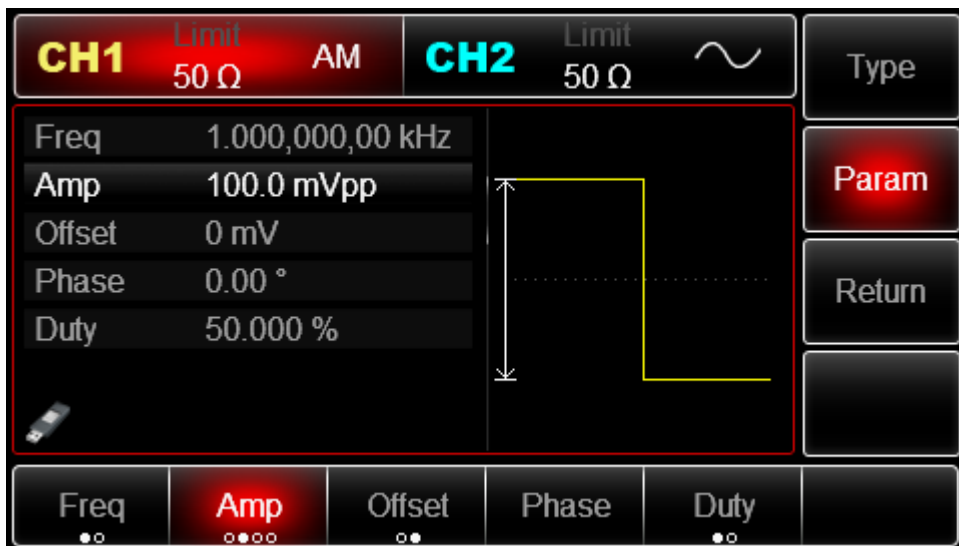

Press corresponding soft key, then enter required numerical value, and select the unit.



Set Modulation Depth

After setting carrier wave parameter, press **Return** soft key to back to the following interface for setting modulation depth.

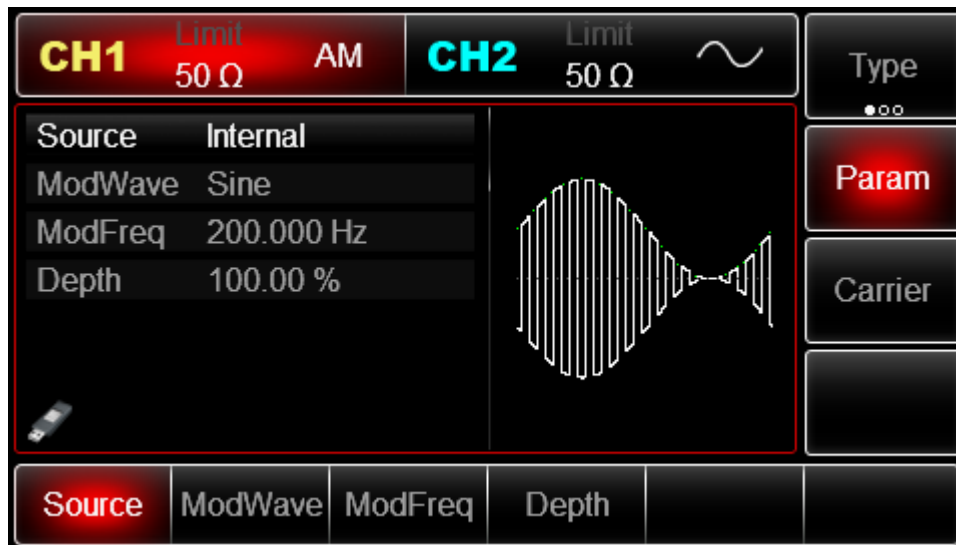

Press **Param** → **depth** soft key again, then enter number 80 and press **%** soft key with number keyboard for setting modulation depth.

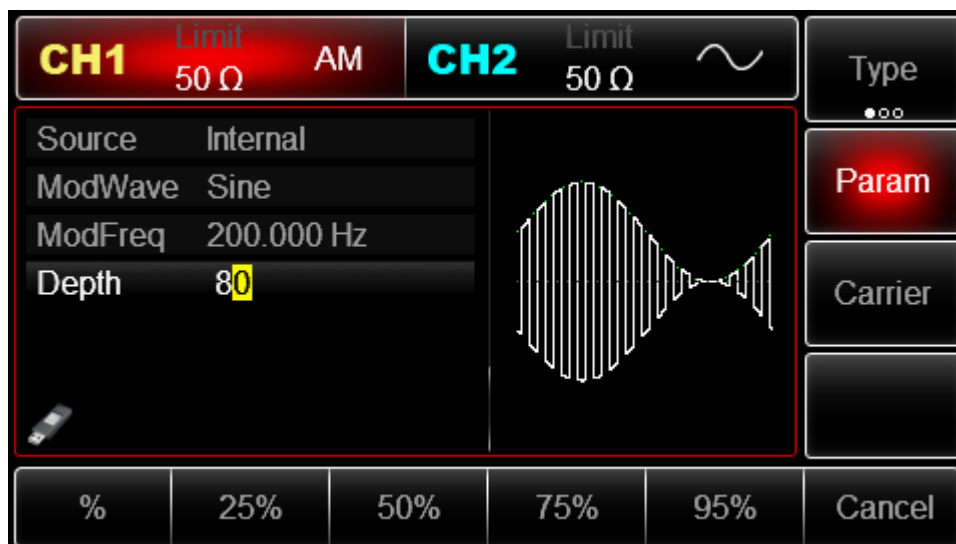

#### Enable Channel Output

Press **CH1** button start channel 1 output quickly. Or enable output by pressing **Utility** and then **CH1 Setting**. After channel output is opened, backlight of **CH1** button is on, and on the right side of channel information label, the font “OFF” changes to “AM”, meaning open channel output.

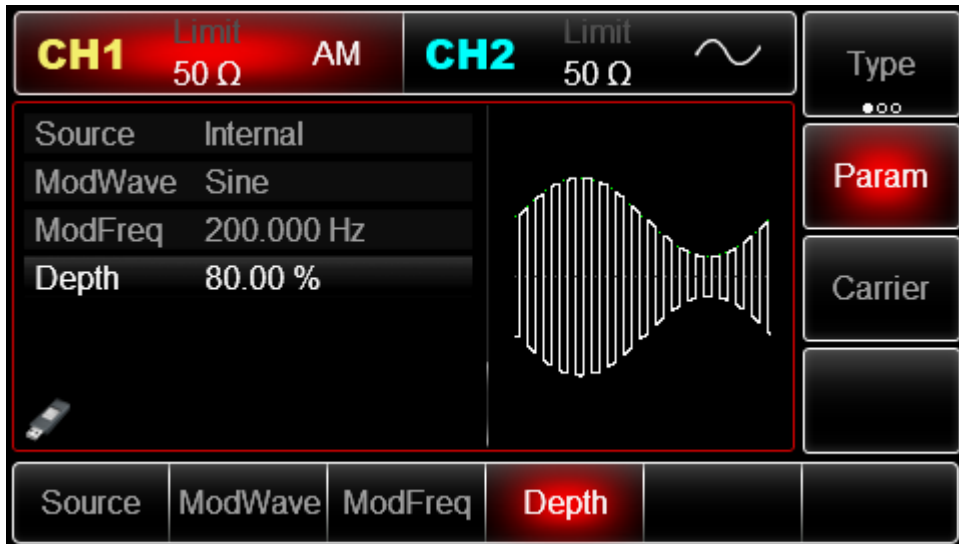

The shape of AM modulation waveform checked through oscilloscope is shown as following:

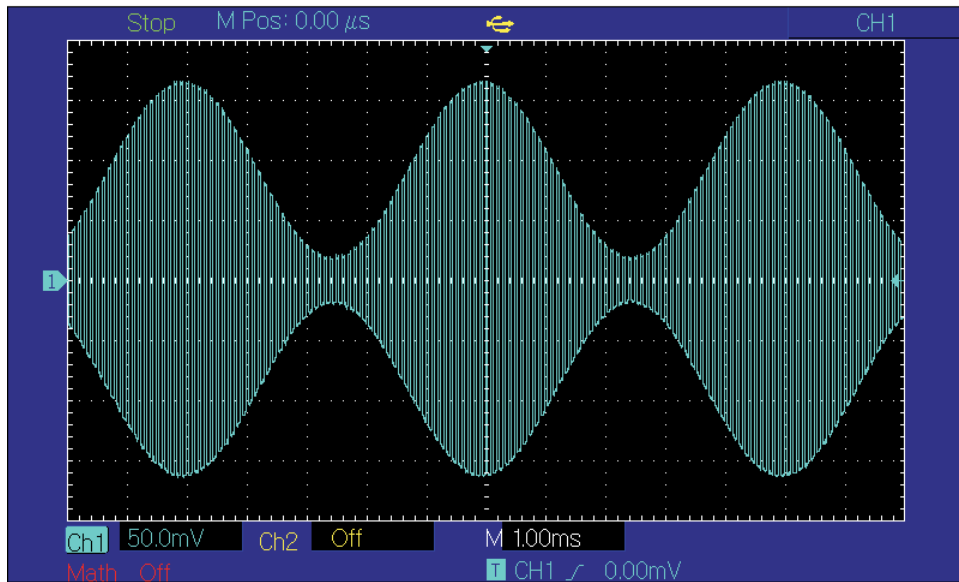

### 3.1.2 Frequency Modulation (FM)

In frequency modulation, modulated waveform is usually composed of carrier wave and modulation wave. Carrier wave frequency will change as the amplitude of modulation wave changes.

Press **Menu** → **Mod** → **Type** → **FM** in turn to start the FM function. The device will output modulated waveform according to the setting of modulation wave and carrier wave.

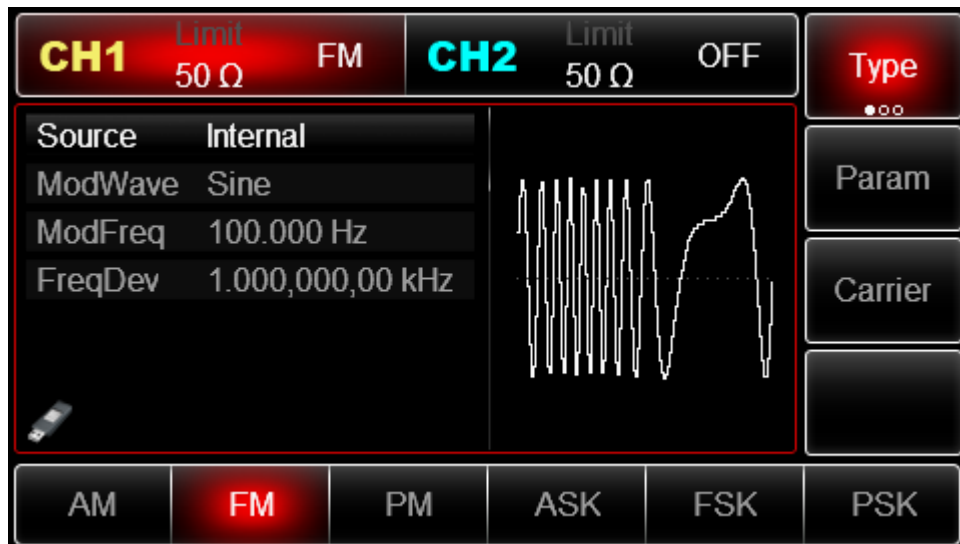

#### Carrier Wave Waveform Selection

FM carrier waveform can be: Sine wave, square wave, ramp wave, pulse wave, arbitrary wave (except DC) and noise (the default is sine wave). After selecting FM modulation, press **Carrier** soft key to enter carrier waveform selection interface.

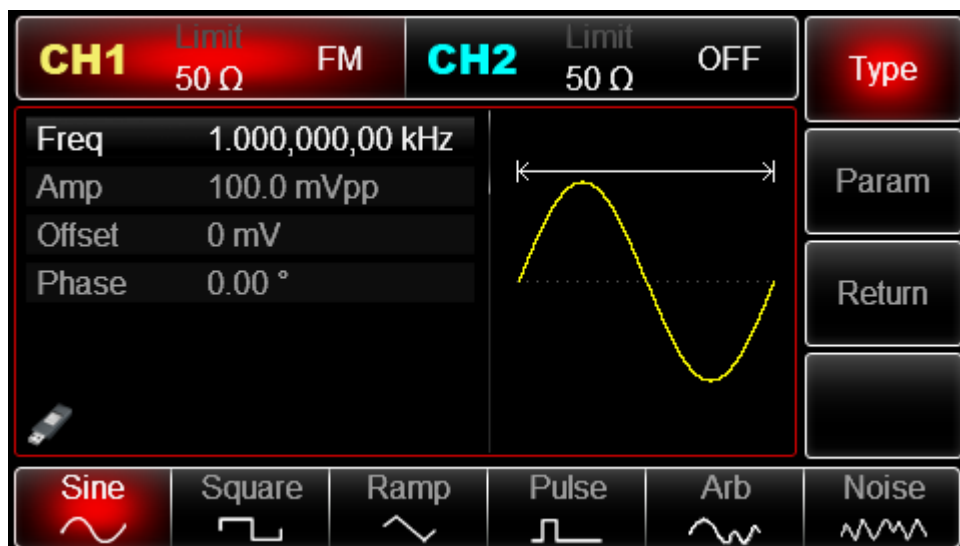

#### Carrier Wave Waveform

FM wave waveform: sine wave, square wave, ramp wave, or arbitrary wave (exp. DC). Default is sine wave. After select FM modulation, press **param**

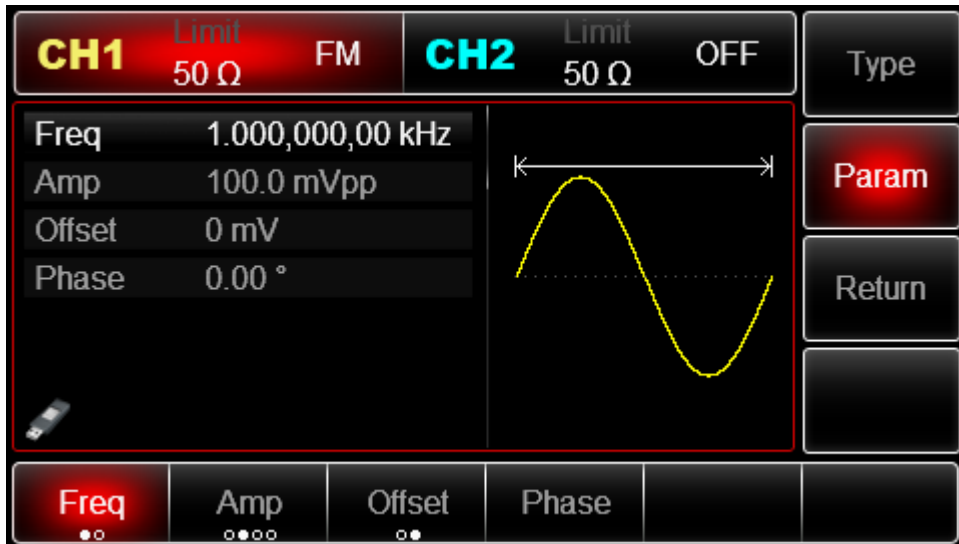

If you need to set up the carrier wave frequency, see Carrier Wave Frequency Setting Modulation Source Selection

This device can select internal modulation source or external modulation source. After enabling FM function, the default of modulation source is internal. If need to change, press `param` → `Source` → `External`

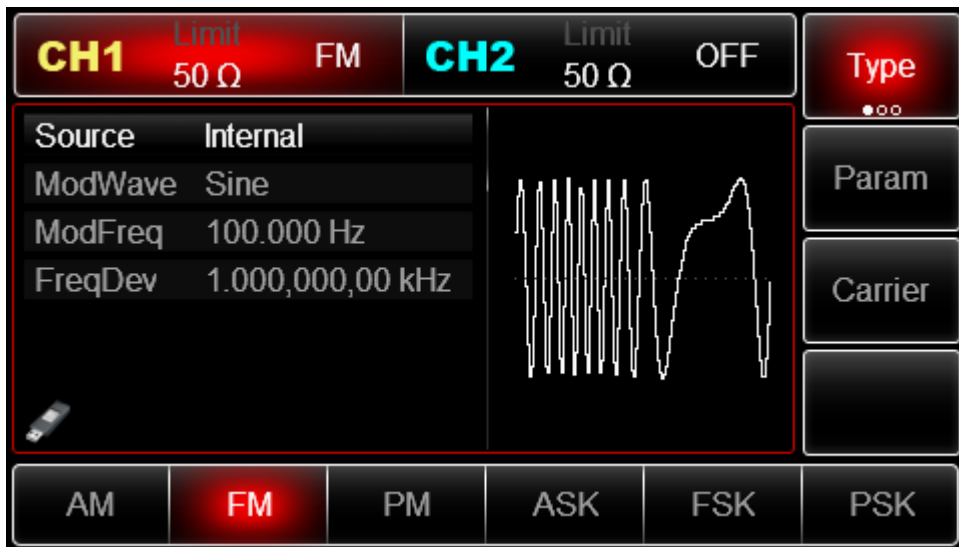

1) Internal Source

When modulation source is internal, modulation wave can be: sine wave, square wave, rising ramp wave, falling ramp wave, arbitrary wave and noise. After enabling FM function, the default of modulation wave is sine wave. If need to change, press `Param` → `ModWave` in turn.

- Square wave: duty ratio is 50%
- Lead Ramp Wave: symmetry degree is 100%
- Tail Ramp Wave: symmetry degree is 0%
- Arbitrary Wave: Arbitrary wave length limit is 4kpts
- Noise: White Gauss noise

2) External Source

When modulation source is external, carrier waveform will be modulated by an external waveform. FM frequency deviation is controlled by  $\pm 5V$  signal level of external modulation input terminal (Modulation In Connector) on front panel. In positive signal level, FM output frequency is

more than carrier wave frequency, while in negative signal level, FM output frequency is less than carrier wave frequency. Low external signal level has small deviation. For example, if the frequency offset is set to 1kHz and the external modulation signal is +5V, FM output frequency will be the current carrier frequency plus 1kHz. When the external modulation signal is -5V, FM output frequency will be the current carrier frequency minus 1kHz.

#### Modulation wave Frequency Setting

When modulation source is internal, frequency of modulation wave can be modulated. After enabling FM function, the default of modulation wave frequency is 100Hz. If need to change, press **Param** → **ModFreq** in turn, and the modulation frequency range is 2mHz to 1MHz. When modulation source is external, parameter list will hide the modulation wave option and modulation frequency option, and carrier waveform will be modulated by an external waveform. The range of modulation signal input from external is 0Hz to 20Hz.

#### Frequency Deviation Setting

Frequency deviation represents the difference between frequency of the FM modulated waveform and the carrier frequency. Settable range of FM frequency deviation is from 1μHz to the maximum of current carrier wave frequency, and the default value is 1kHz. If need to change, press **Param** → **FreqDev** in turn.

Frequency deviation  $\leq$  carrier wave frequency. If frequency deviation value is set higher than carrier wave frequency, the device will automatically set the offset value to the carrier frequency's maximum allowable frequency.

frequency deviation + carrier wave frequency must  $\leq$  the allowed maximal frequency of current carrier wave. If the frequency deviation value is set to an invalid value, the device will automatically set the offset value to the carrier frequency's maximum allowable frequency.

#### Comprehensive Example:

Make the instrument work in frequency modulation (FM) mode, then set a sine wave with 2kHz from the internal of the instrument as a modulation signal and a square wave with frequency of 10kHz and amplitude of 100mVpp as a carrier wave signal. Finally, set frequency deviation to 5kHz. Specific steps are seen as following:

#### 3) Enable Frequency Modulation (FM) Function

Press **Menu** → **Mod** → **Type** → **FM** in turn to start the FM function.

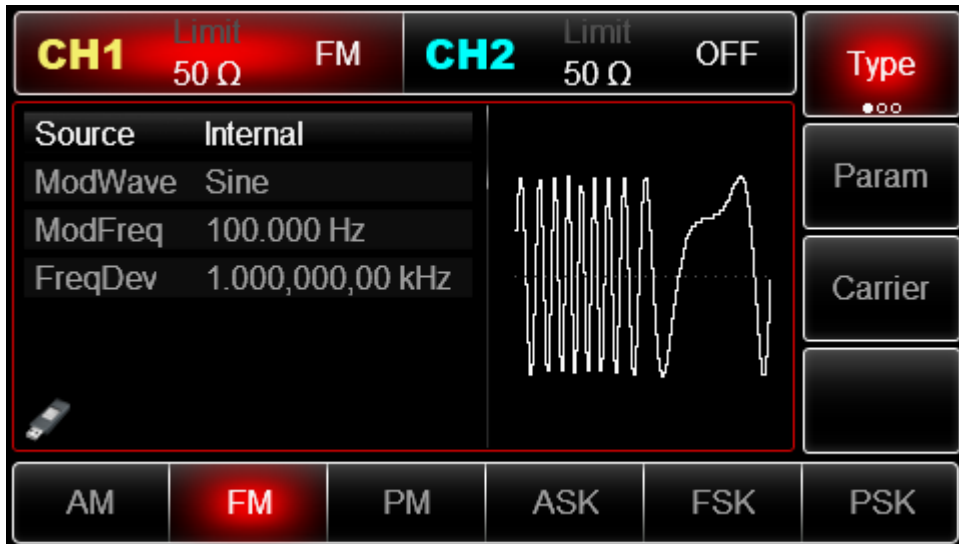

Set Modulation Signal Parameter

Press **Param** soft key. Then the interface will show as following:

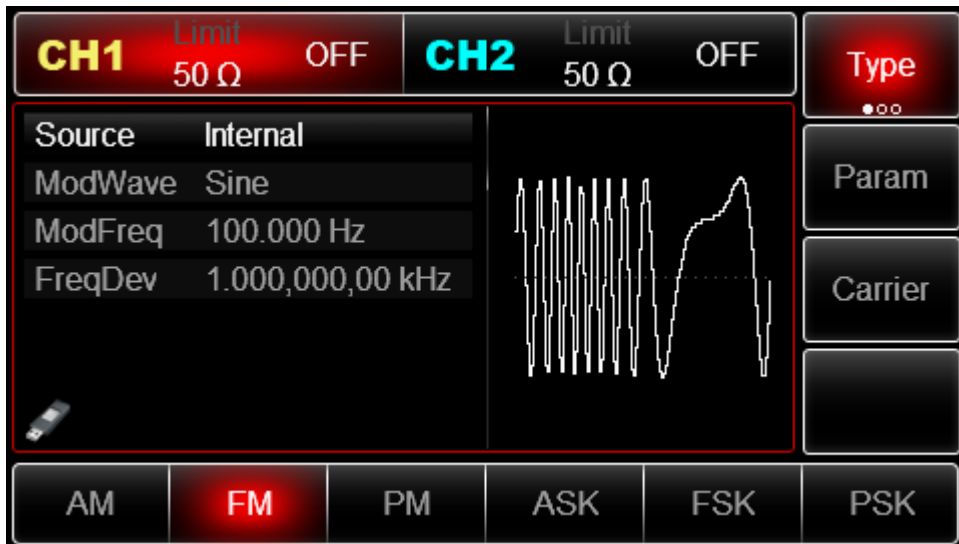

Press corresponding soft key, then enter required numerical value, and select the unit.

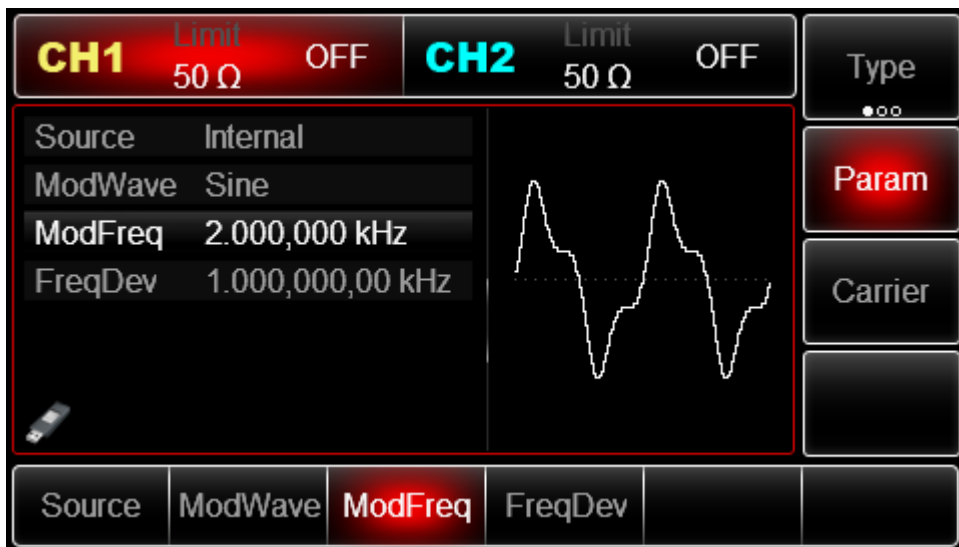

Set Carrier Wave Signal Parameter

Press **Carrier** → **Type** → **Sine** in turn to select sine wave as carrier wave signal.

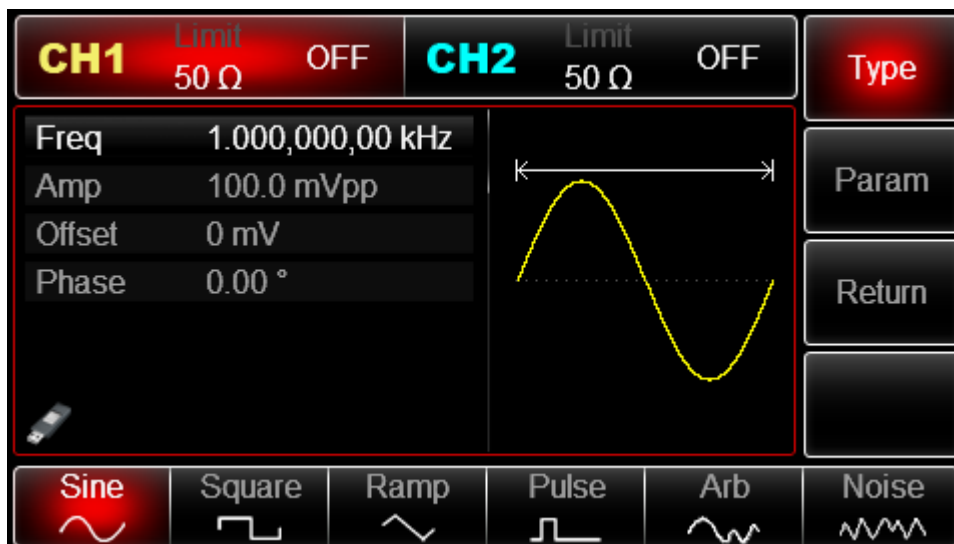

Press **Param** soft key, and the interface will pop up as following:

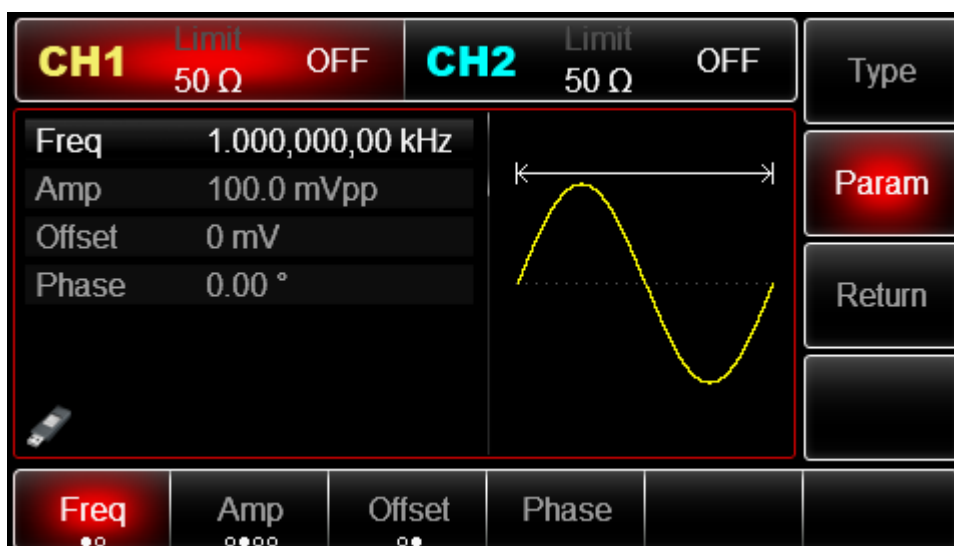

Press corresponding soft key first, then enter required numerical value, and select the unit.

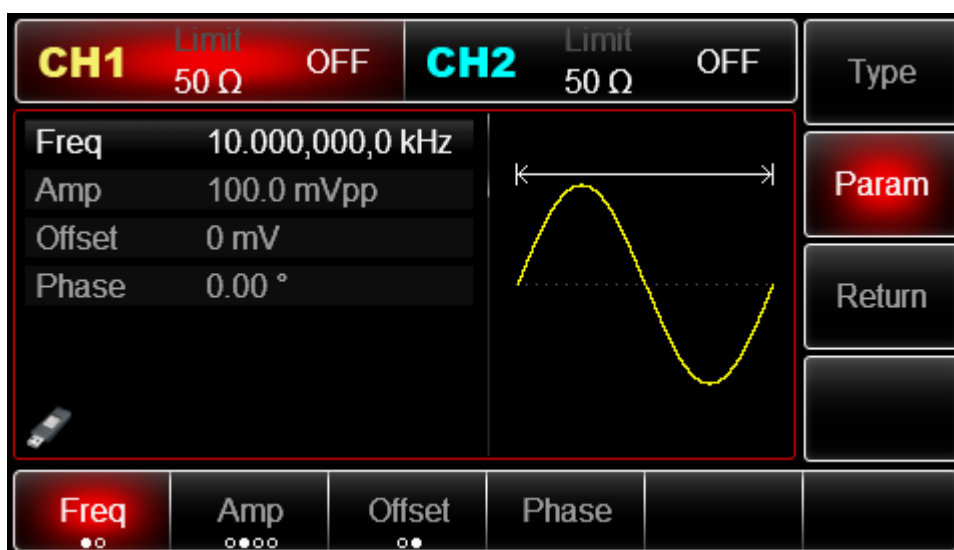

Set Frequency Deviation

After setting carrier wave parameter, press **Return** soft key to back to the following interface for setting frequency deviation.

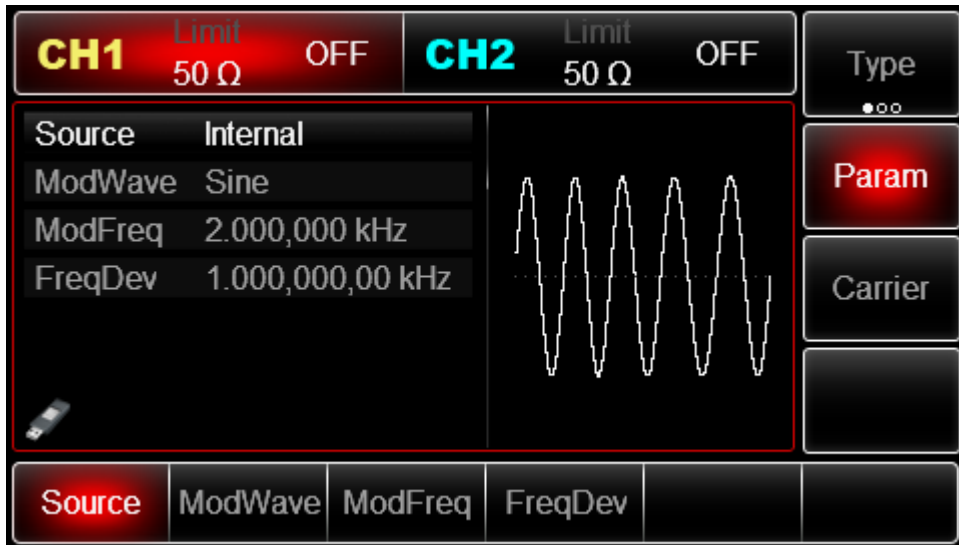

Press **Param** → **FreDev** soft key, then enter number 5 and press **kHz** soft key with number keyboard for setting frequency deviation.

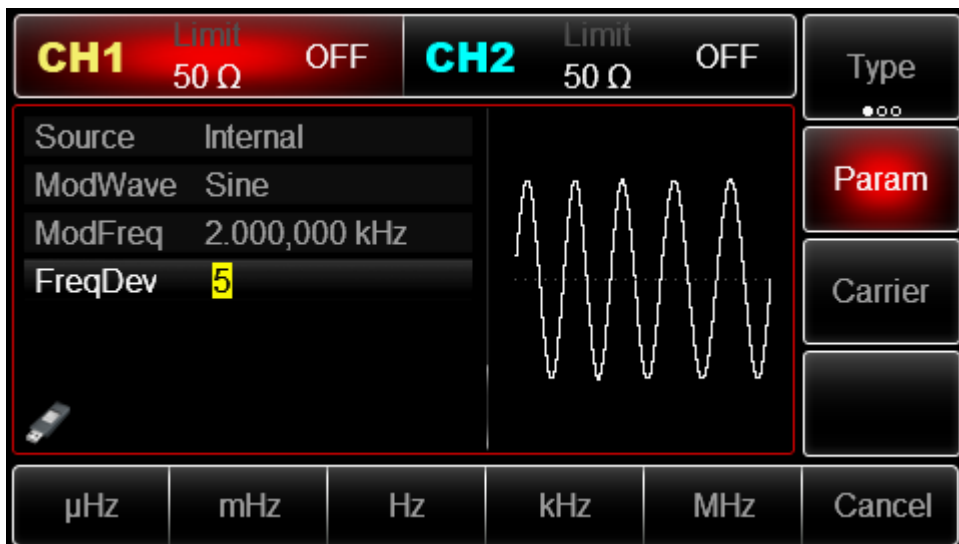

Press **CH1** button start channel 1 output quickly. Or enable output by pressing **Utility** and then **CH1 Setting**. After channel output is opened, backlight of **CH1** button is on, and on the right side of channel information label, the font “OFF” changes to “FM”, meaning open channel 1 output.

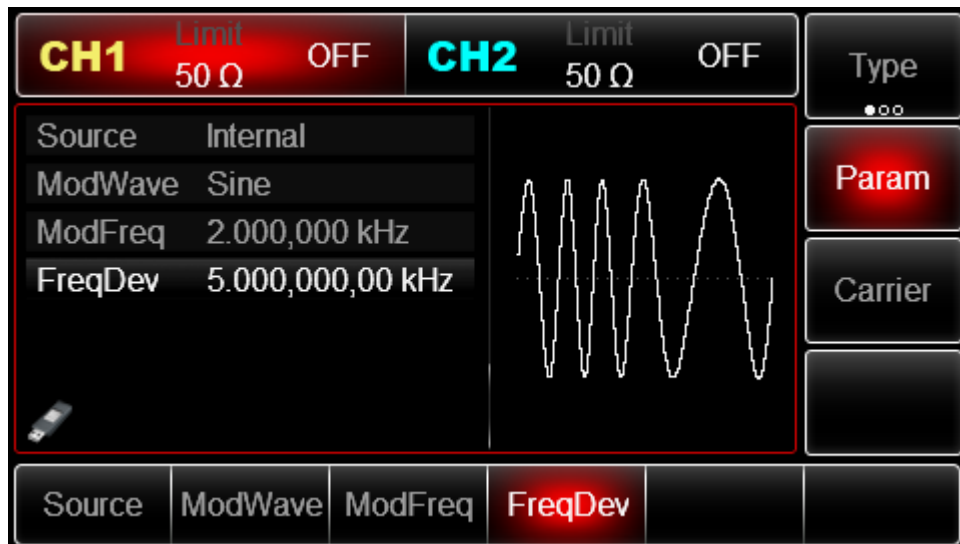

The shape of FM modulation waveform checked through oscilloscope is shown as following:

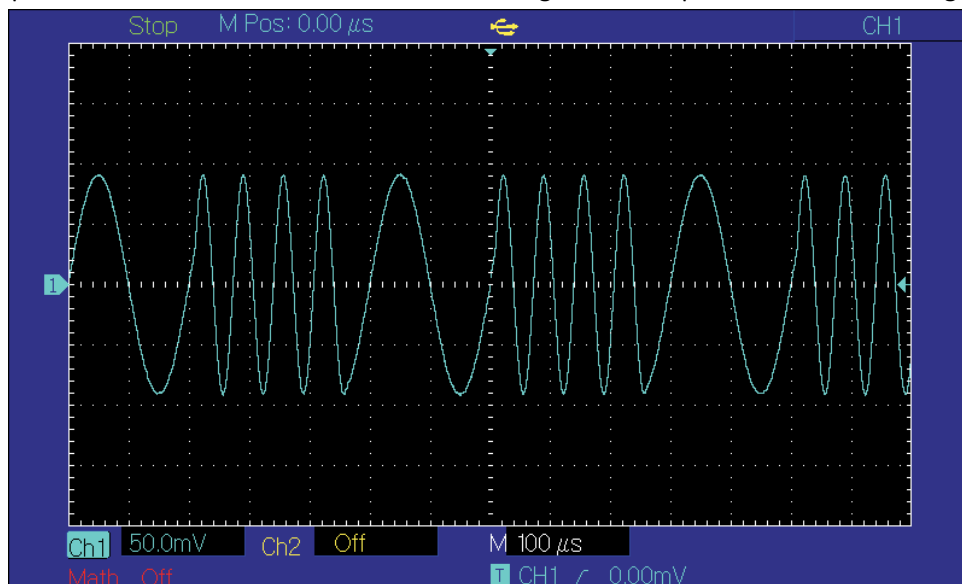

### 3.1.3 Phase Modulation (PM)

In phase modulation, modulated waveform is usually composed of carrier wave and modulation wave. The modulation of CH1 and CH2 is independent, you can set up the same or different mode for them.

Press **Menu** → **Mod** → **Type** → **PM** in turn to start the PM function. The device will output modulated waveform with modulation waveform and carrier wave set currently.

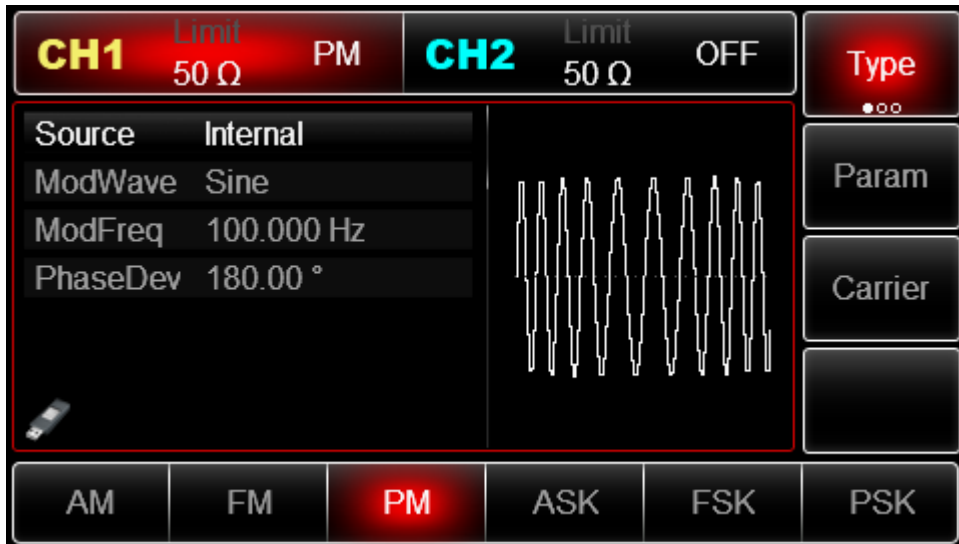

Carrier Wave Waveform Selection

PM carrier waveform can be: Sine wave, square wave, ramp wave or arbitrary wave (except DC), and the default is sine wave. Press **Carrier** soft key to select carrier waveform.

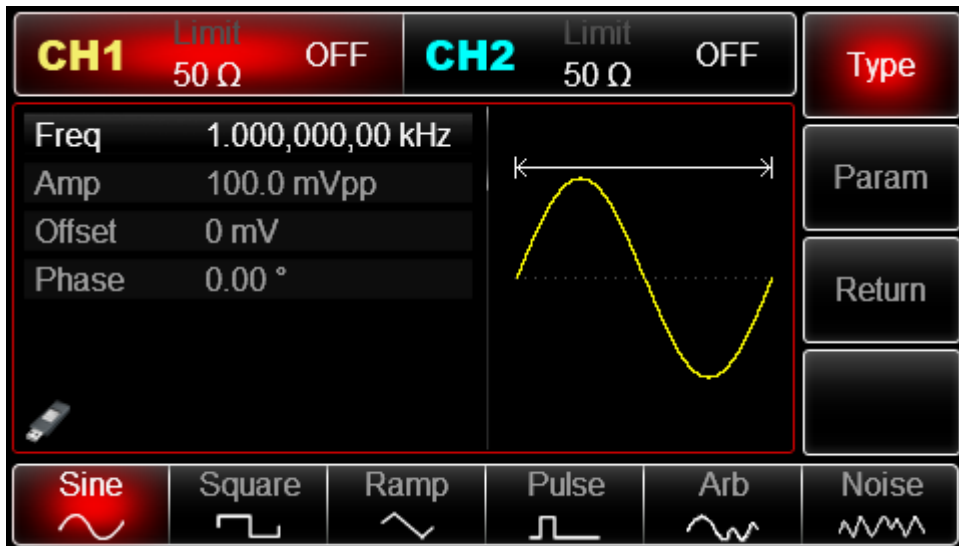

Carrier Wave Frequency Setting

If you need to set up the carrier wave frequency, see Carrier Wave Frequency Setting

Modulation Source Selection

This device can select internal modulation source or external modulation source. After enabling PM function, the default of modulation source is internal. If need to change, press **Param** → **Source** → **External** in turn.

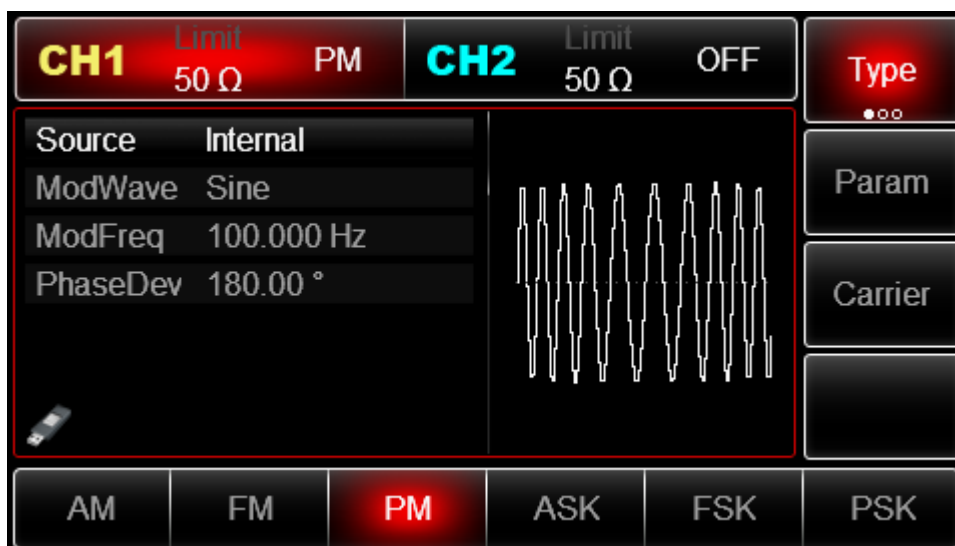

### 1) Internal Source

When modulation source is internal, modulation wave can be: sine wave, square wave, rising ramp wave, falling ramp wave, arbitrary wave and noise. After enabling FM function, the default of modulation wave is sine wave. If need to change, press **Param** → **ModWave** in turn.

- Square wave: duty ratio is 50%
- Lead Ramp Wave: symmetry degree is 100%
- Tail Ramp Wave: symmetry degree is 0%
- Arbitrary Wave: Arbitrary wave length limit is 4kpts
- Noise: White Gauss noise

### 2) External Source

When modulation source is external, carrier waveform will be modulated by an external waveform. PM phase deviation is controlled by  $\pm 5V$  signal level of external modulation input terminal on rear panel. For example, if phase deviation value in parameter list has been set to  $180^\circ$ ,  $+5V$  of external modulation signal is equivalent to  $180^\circ$  phase shift. Lower external signal produce smaller deviation.

#### Modulation wave Frequency Setting

When modulation source is internal, frequency of modulation wave can be modulated. After enabling PM function, the default of modulation wave frequency is 100Hz. If need to change, press **Param** → **ModFreq** in turn, and the modulation frequency range is 2mHz to 1MHz. When modulation source is external, carrier waveform will be modulated by an external waveform. The range of modulation signal input from external is 0Hz to 20Hz.

#### Phase Deviation Setting

Phase deviation indicates the change between the phases of PM modulated waveform and the phase of carrier wave phase. Settable range of PM phase deviation is from  $0^\circ$  to  $360^\circ$ , and the default value is  $180^\circ$ . If need to change, press **Param** → **Phase Dev** in turn.

#### Comprehensive Example

Firstly, make the instrument work in phase modulation (PM) mode, then set a sine wave with 200Hz from the internal of the instrument as a modulation signal and a square with frequency of 900Hz and amplitude of 100mVpp as a carrier wave signal. Finally, set the phase deviation to  $200^\circ$ . Specific steps are seen as following:

3) Enable Phase Modulation (PM) Function

Press Menu → **Mod** → **Type** → **PM** in turn to start the PM function.

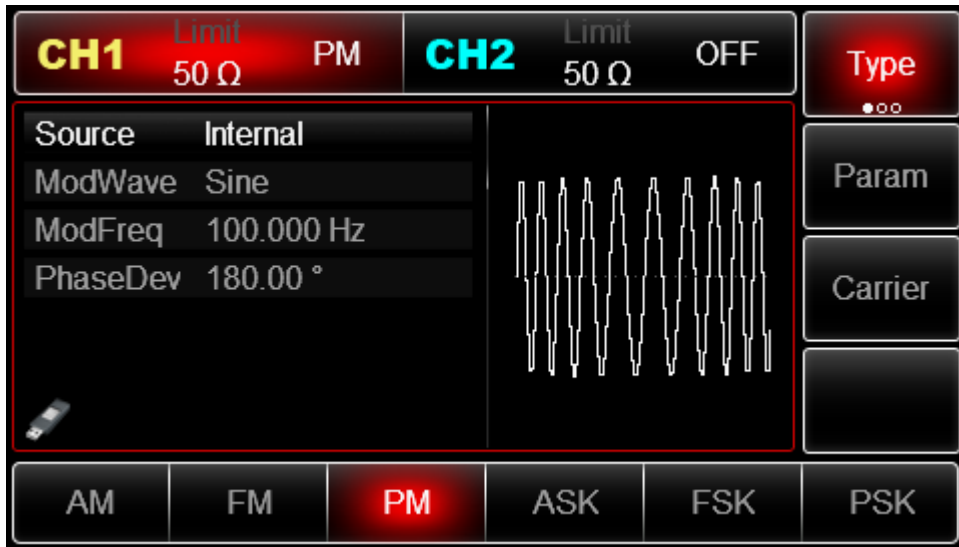

Set Modulation Signal Parameter

Press **Param** soft key and the interface will show as following:

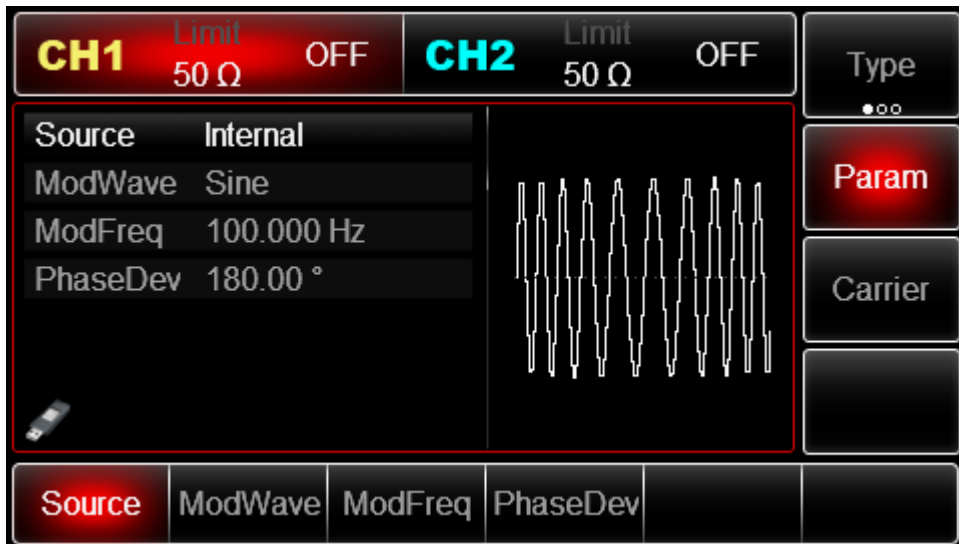

Press **corresponding** soft key first, then enter required numerical value, and select the unit.

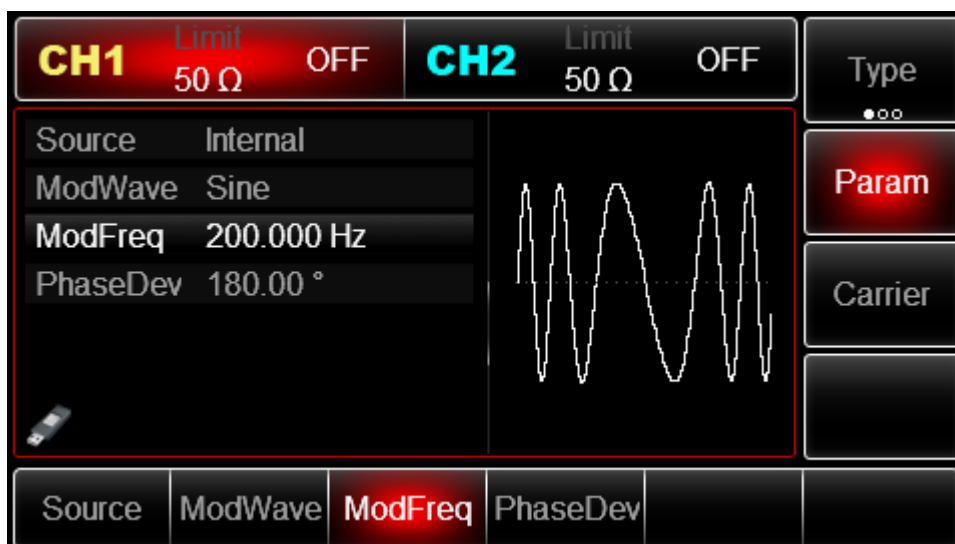

Set Carrier Wave Signal Parameter

Press **Carrier** → **Type** → **Sine** in turn to select sine wave as carrier wave signal.

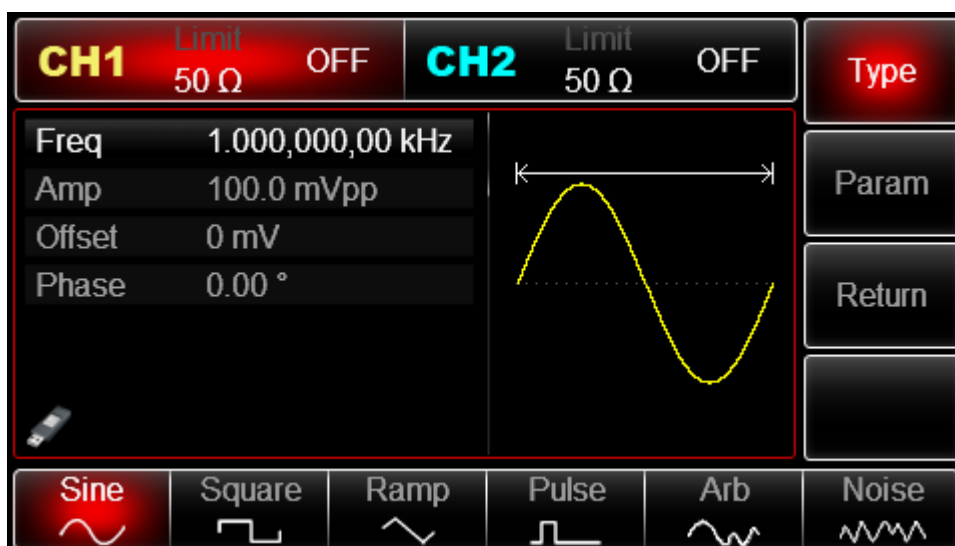

Press **Param** soft key, and the interface will pop up as following:

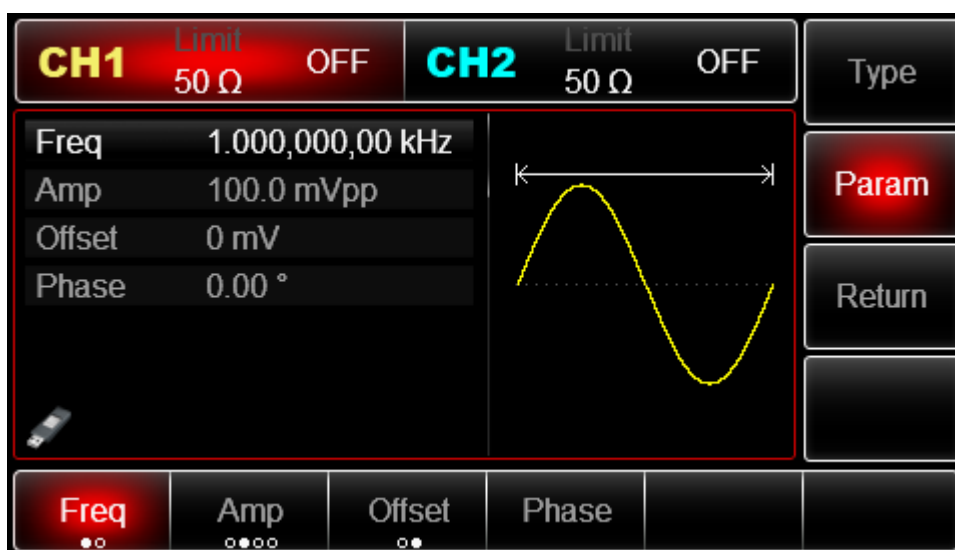

Press corresponding soft key, then enter required numerical value, and select the unit.

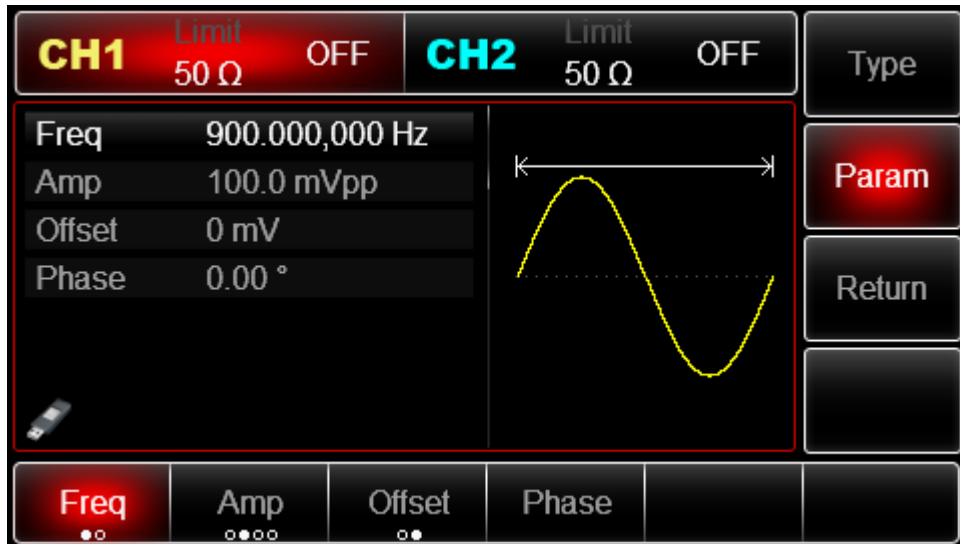

Set Phase Deviation

Press **Return** soft key to back to the following interface for setting phase modulation.

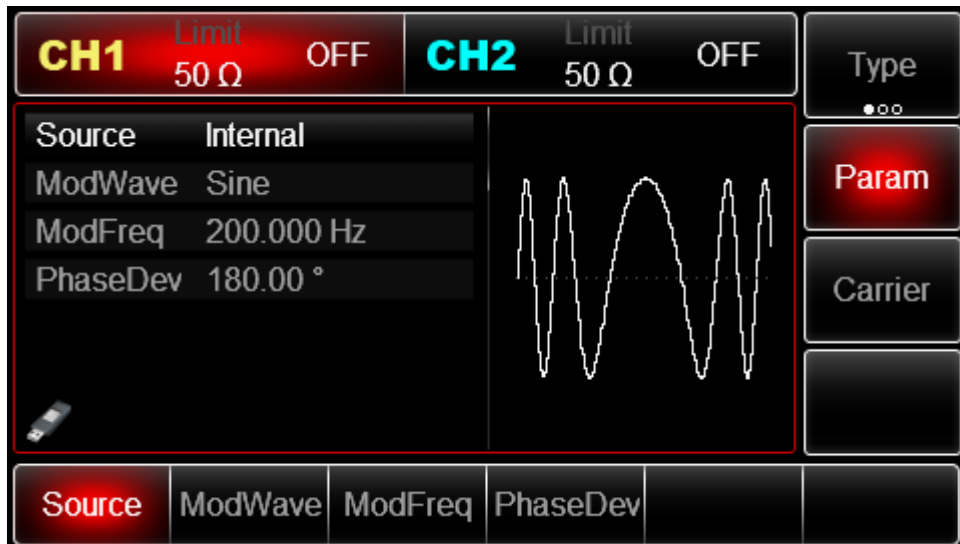

Press **Param** → **PhaseDev** soft key, then enter number 200 and press ° soft key with number keyboard for setting phase deviation.

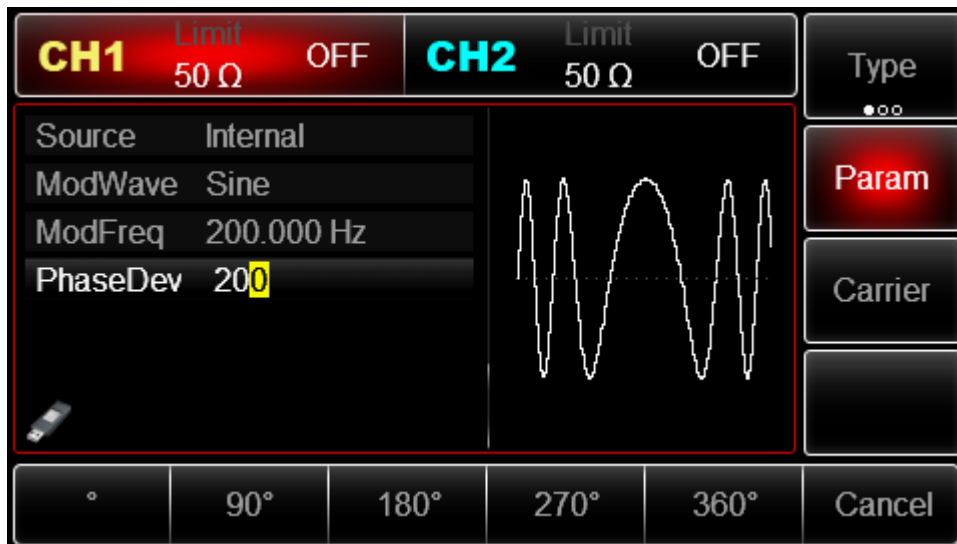

Enable Channel Output

Press **CH1** button start channel 1 output quickly. Or enable output by pressing **Utility** and then **CH1 Setting**. After channel output is opened, backlight of **CH1** button is on, and on the right side of channel information label, the font “OFF” changes to “PM”, meaning open channel output.

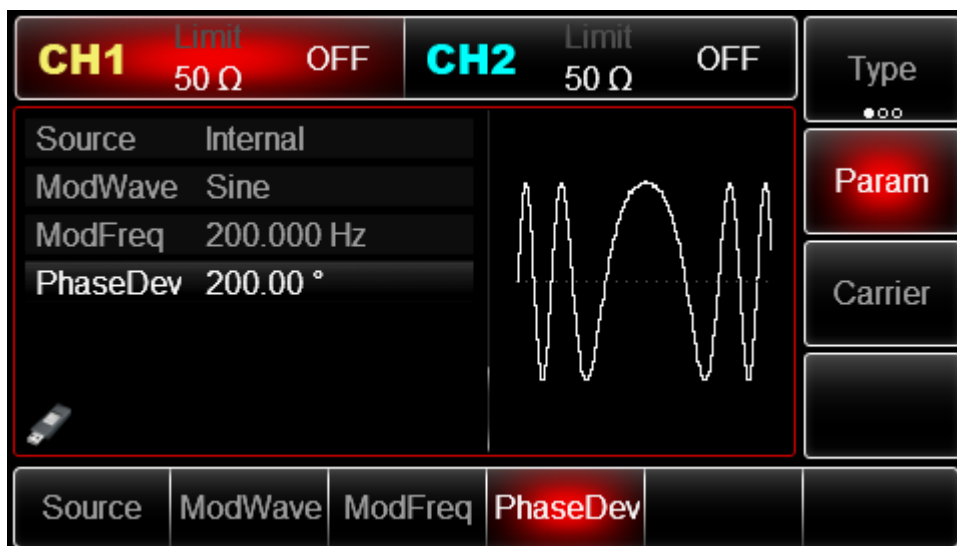

The shape of PM modulation waveform checked through oscilloscope is shown as following:

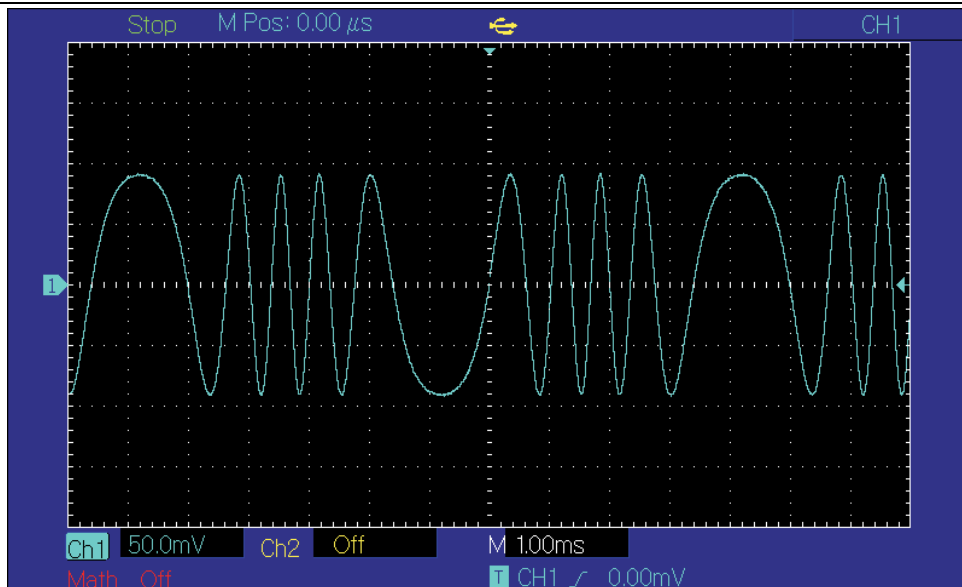

### 3.1.4 Amplitude Shift Keying (ASK)

ASK shows digital signal “0” and “1” by changing amplitude of carrier wave signal. Carrier wave signal with different amplitude will be output on the basis of different logic of modulation signal.

#### ASK Modulation Selection

Press **Menu** → **Mod** → **Type** → **ASK** in turn to start the ASK function, the device will output modulated waveform with ASK rate and carrier wave set currently.

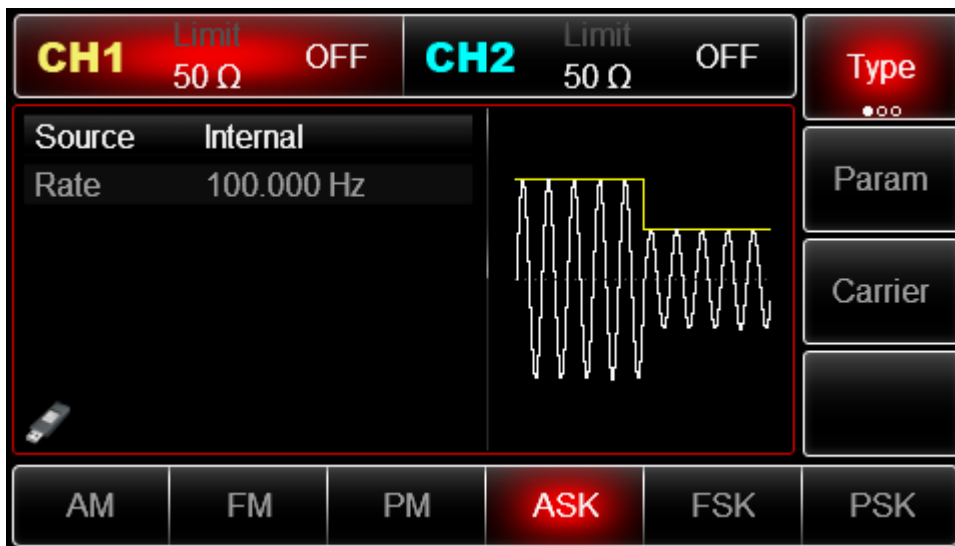

#### Carrier Wave Waveform Selection

ASK carrier waveform can be: Sine wave, square, ramp wave or arbitrary wave (except DC), and the default is sine wave. Press **Carrier** soft key to enter carrier waveform selection interface.

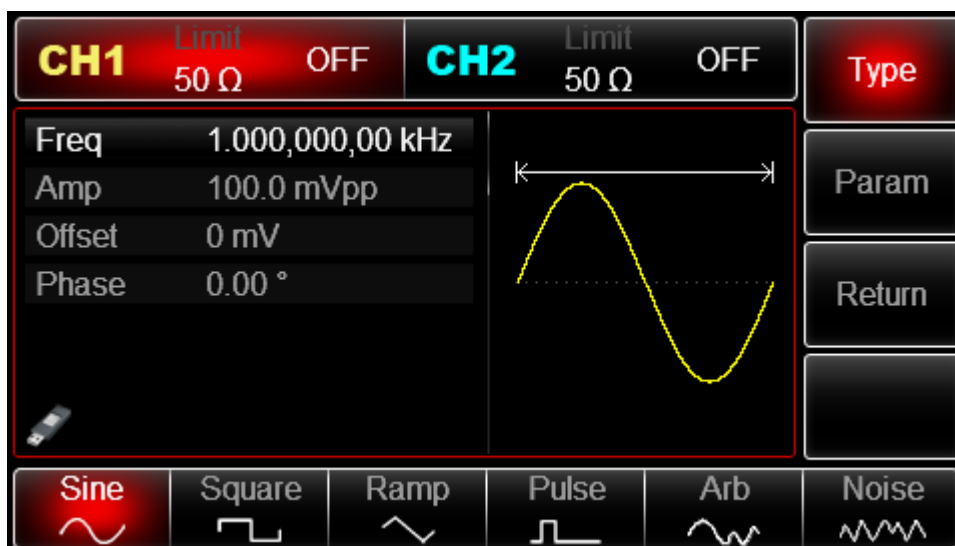

### Carrier Wave Frequency Setting

See Carrier Wave Frequency Setting

### Modulation Source Selection

The device can select internal modulation source or external modulation source. After enabling ASK function, the default of modulation source is internal. If need to change, press **Param** → **Source** → **External** in turn.

#### 1) Internal Source

When modulation source is internal, internal modulation wave is a square wave of 50% duty ratio (not adjustable). The ASK rate can be set to customize modulated waveform amplitude hopping frequency.

#### 2) External Source

When modulation source is external, carrier waveform will be modulated by an external waveform. ASK output amplitude is determined by the logic level of modulation interface (FSK Trig connector). For example, output the carrier wave amplitude of current setting when external input logic is low, and output currently set carrier wave amplitude, when input logic is high, output amplitude is less than currently set carrier wave amplitude.

### ASK Rate Setting

When modulation source is internal, frequency of ASK amplitude jump can be modulated. After enabling ASK function, ASK rate can be set and the settable range is 2mHz to 1MHz, the default rate is 100Hz. If need to change, press **Param** → **Rate** in turn.

### Comprehensive Example

Make the instrument work in amplitude shift keying (ASK) mode, then set a logic signal with 300Hz from the internal of the instrument as a modulation signal and a sine wave with frequency of 15kHz and amplitude of 2Vpp as a carrier wave signal. Specific steps are seen as following:

35

#### 3) Enable Amplitude Shift Keying (ASK) Function

Press **Menu** → **Mod** → **Type** → **ASK** in turn to start the ASK function.

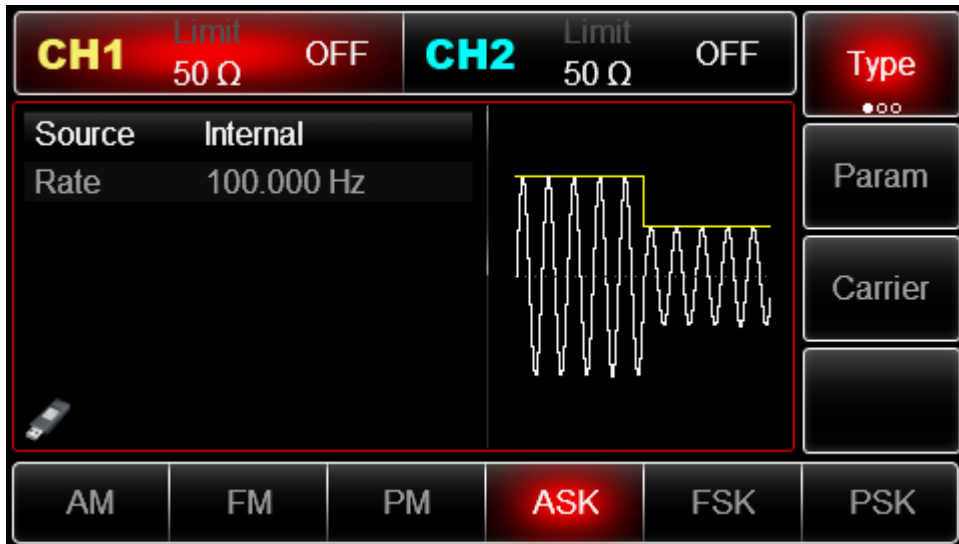

Set Carrier Wave Signal Parameter Press **Carrier** → **Type** → **Sine** in turn

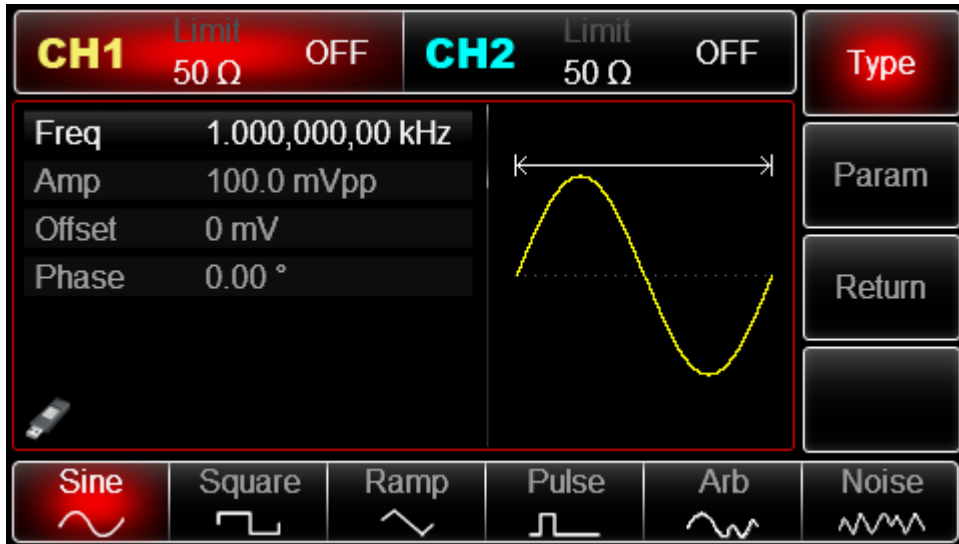

Press **Param** soft key, and the interface will pop up as following:

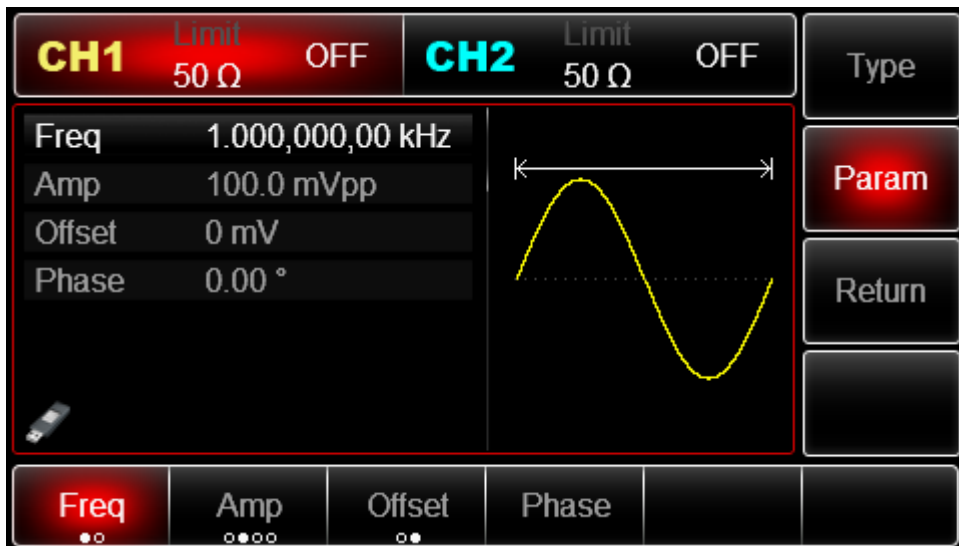

Press corresponding soft key, then enter required numerical value, and select the unit.

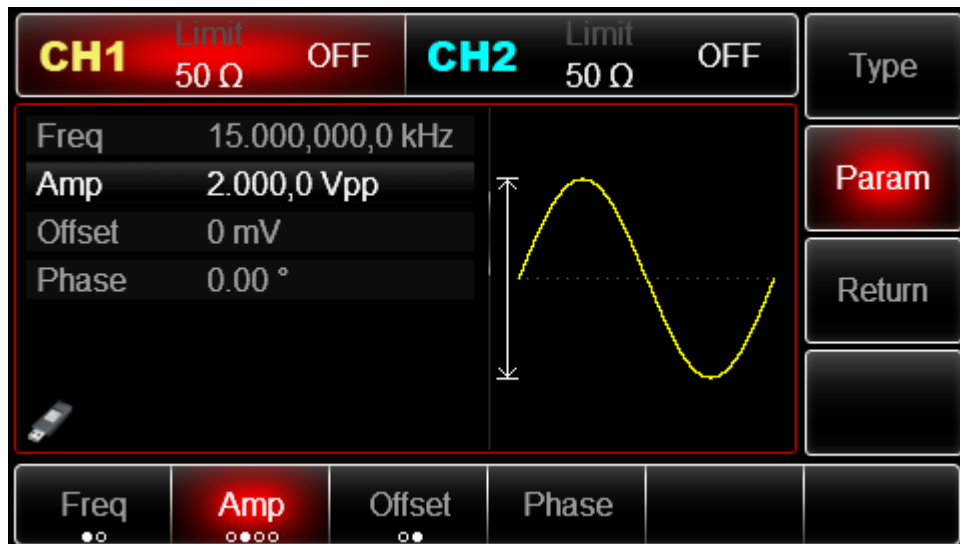

Set ASK Rate

After setting carrier wave parameter, press **Return** soft key to go back to the following interface for setting phase modulation.

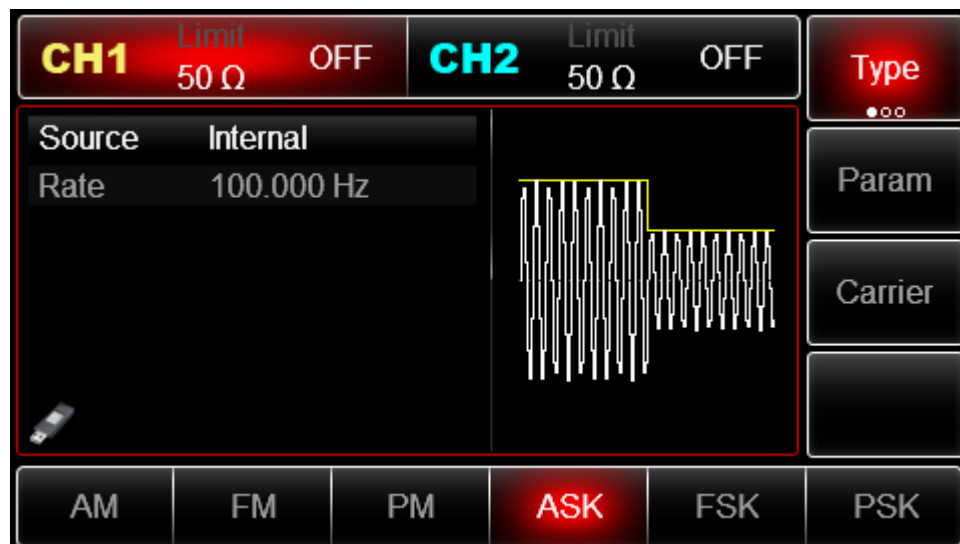

Press **Param** → **Rate** soft key again, then enter number 300 and press **Hz** soft key with number keyboard for setting ASK rate.

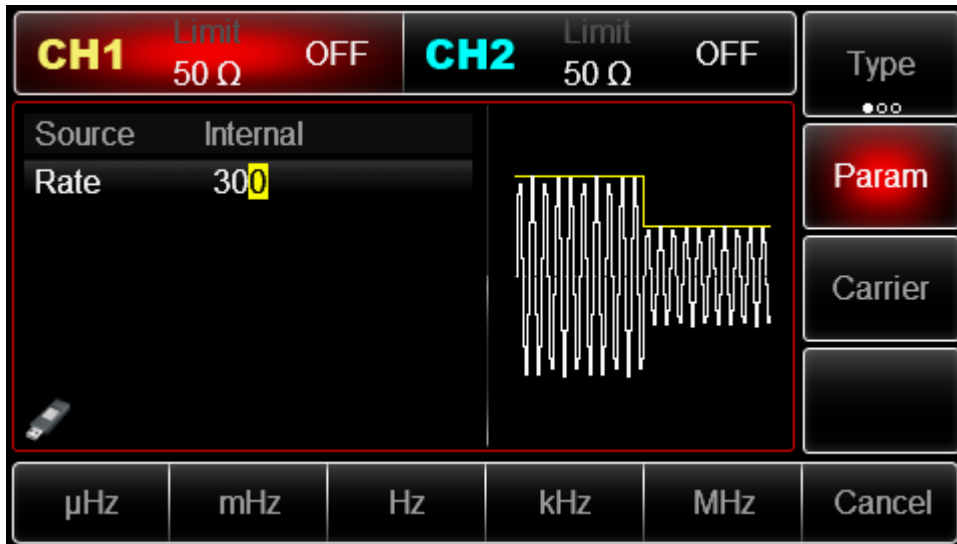

**Enable Channel Output**

Press **CH1** button start channel 1 output quickly. Or enable output by pressing **Utility** and then **CH1 Setting**. After channel output is opened, backlight of **CH1** button is on, and on the right side of channel information label, the font “OFF” changes to “ASK”, meaning open channel output.

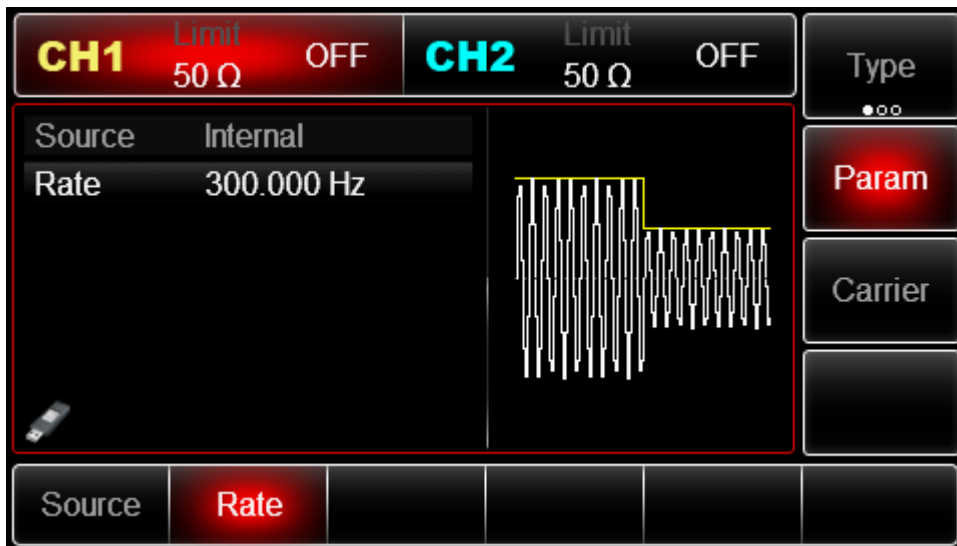

The shape of ASK modulation waveform checked through oscilloscope is shown as following:

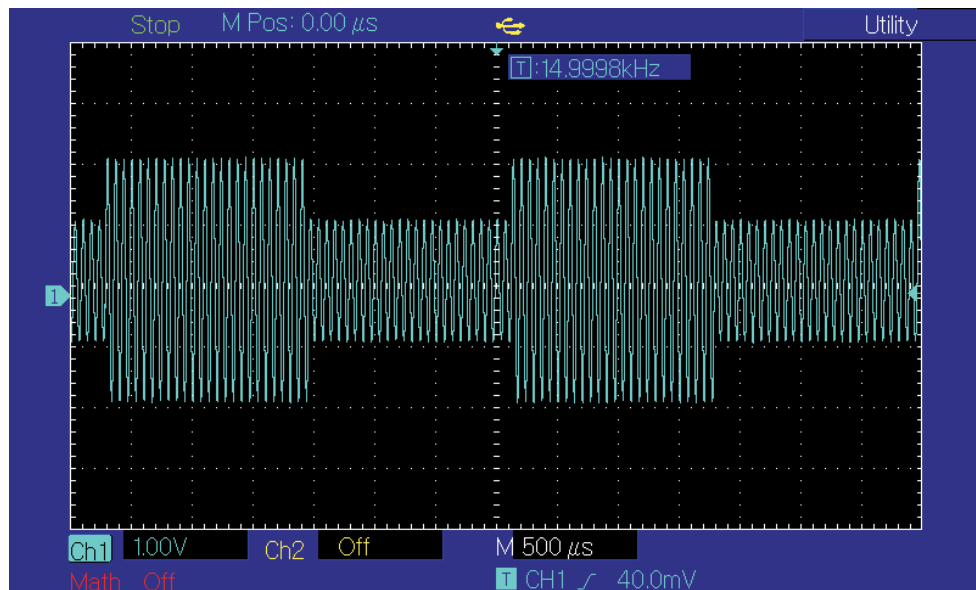

### 3.1.5 Frequency Shift Keying (FSK)

In frequency shift keying, rate of carrier wave frequency and hopping frequency can be changed.

FSK Modulation Selection

Press **Menu** → **Mod** → **Type** → **FSK** in turn to start the FSK function. The device will output modulated waveform with current setting.

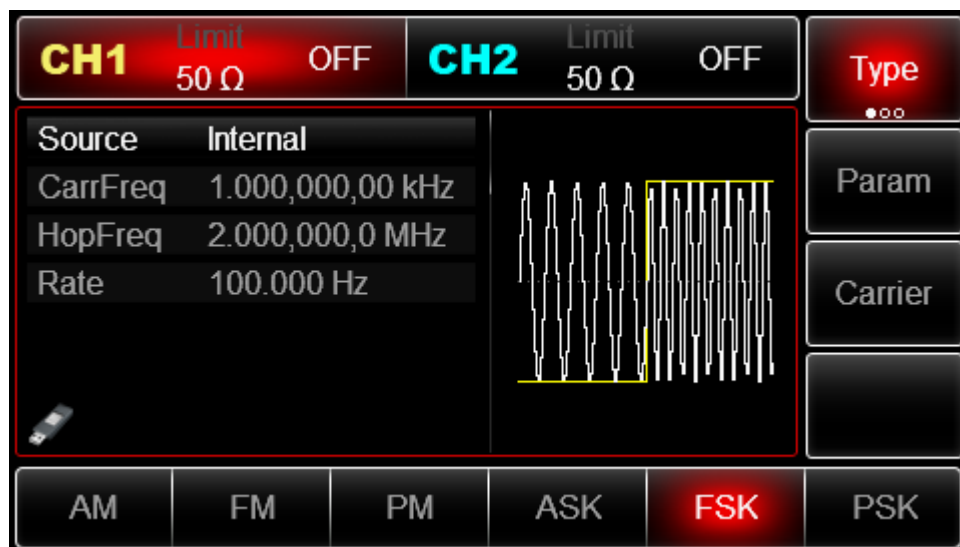

Carrier Wave Waveform Selection

Press **Carrier** soft key to enter carrier waveform selection interface. FSK carrier waveform can be: sine wave, square wave, ramp wave or arbitrary wave (except DC), and the default is sine wave.

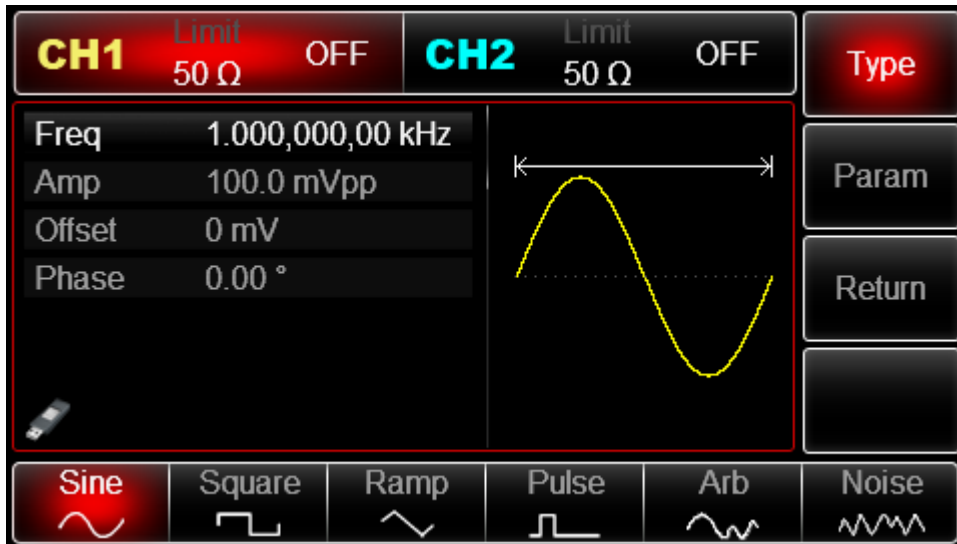

Carrier Wave Frequency Setting

See Carrier Wave Frequency Setting

Modulation Source Selection

The device can select internal modulation source or external modulation source. After enabling FSK function, the default of modulation source is internal. If need to change, press **Param** → **Source** → **External** in turn.

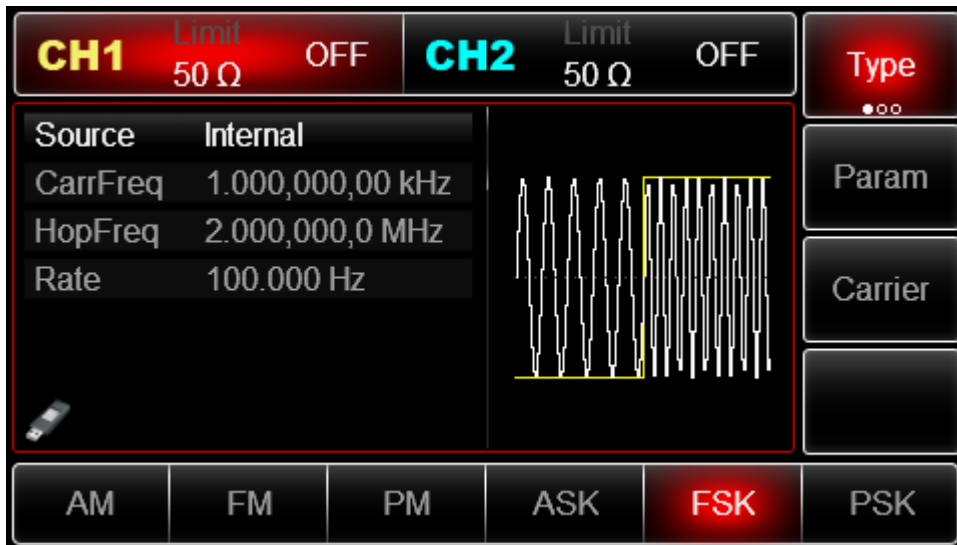

1) Internal Source

When modulation source is internal, internal modulation wave is a square of 50% duty ratio (not adjustable). The FSK rate can be set to customize the moving frequency between carrier wave frequency and hop frequency.

2) External Source

When modulation source is external, carrier waveform will be modulated by an external waveform. FSK output frequency is determined by the logic level of modulation interface on front panel. For example, output the carrier wave frequency when external output logic is low, and output hop frequency when external input logic is high.

## Hop Frequency Setting

After enabling FSK function, the default of hop frequency is 2MHz. If need to change, press **Param** → **HopFreq** in turn. Settable range of hop frequency is determined by carrier wave waveform. See Carrier Wave Frequency Setting

## FSK Rate Setting

When modulation source is internal, the moving frequency between carrier wave frequency and hop frequency can be set. After enabling FSK function, FSK rate can be set and the settable range is 2mHz to 1MHz, the default rate is 100Hz. If need to change, press

**Param** → **Rate** in turn. Please refer to Carrier Wave Frequency to set up the frequency.

## Comprehensive Example

Firstly, make the instrument work in frequency shift keying (FSK) mode, then set a sine wave with 2kHz and 1Vpp from the internal of the instrument as a carrier wave signal, and set hop frequency to 800 Hz, finally, make carrier wave frequency and hop frequency move between each other with 200Hz frequency. Specific steps are seen as following:

## 3) Enable Frequency Shift Keying (FSK) Function

Press **Menu** → **Mod** → **Type** → **FSK** in turn to start the FSK function.

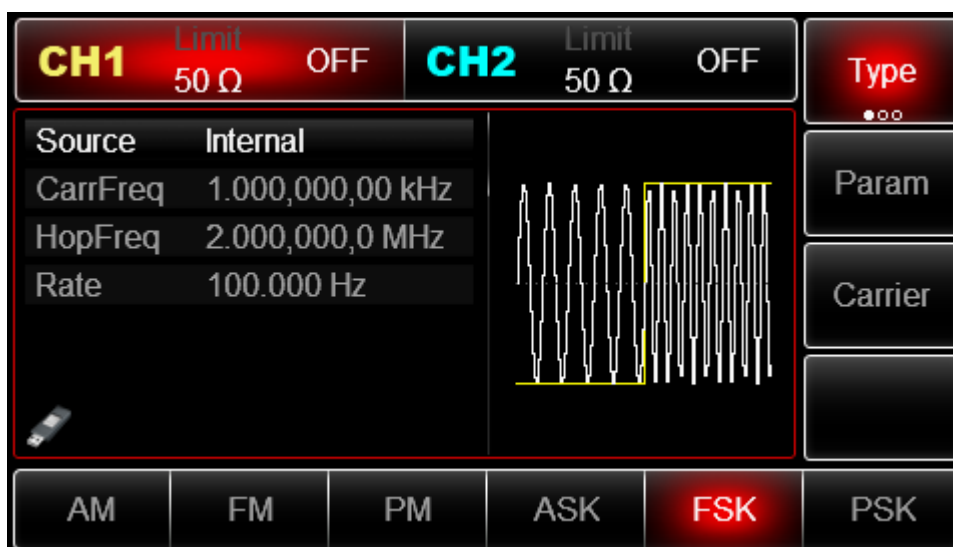

## Set Carrier Wave Signal Parameter

Press **Carrier** → **Type** → **Sine** in turn to select sine wave as carrier wave.

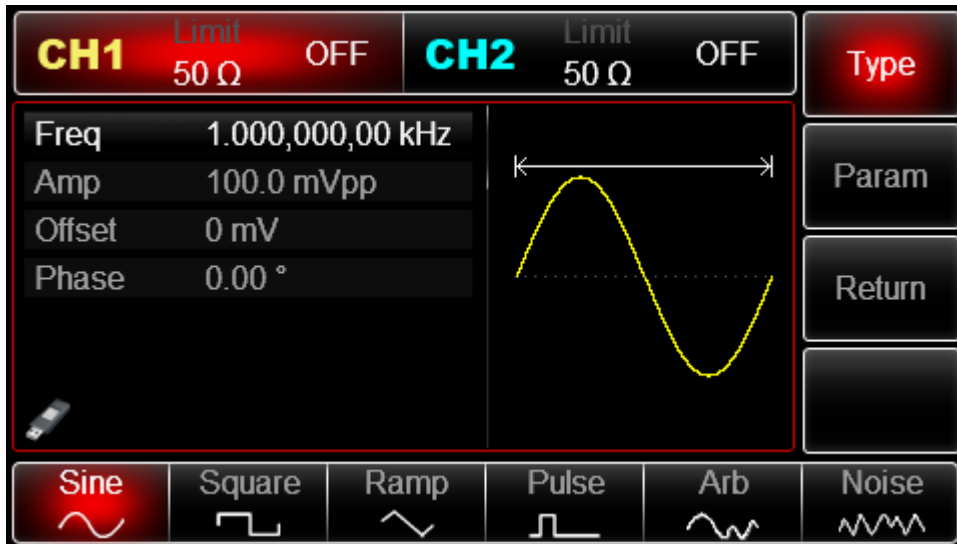

Press **Param** soft key again, and the interface will pop up as following

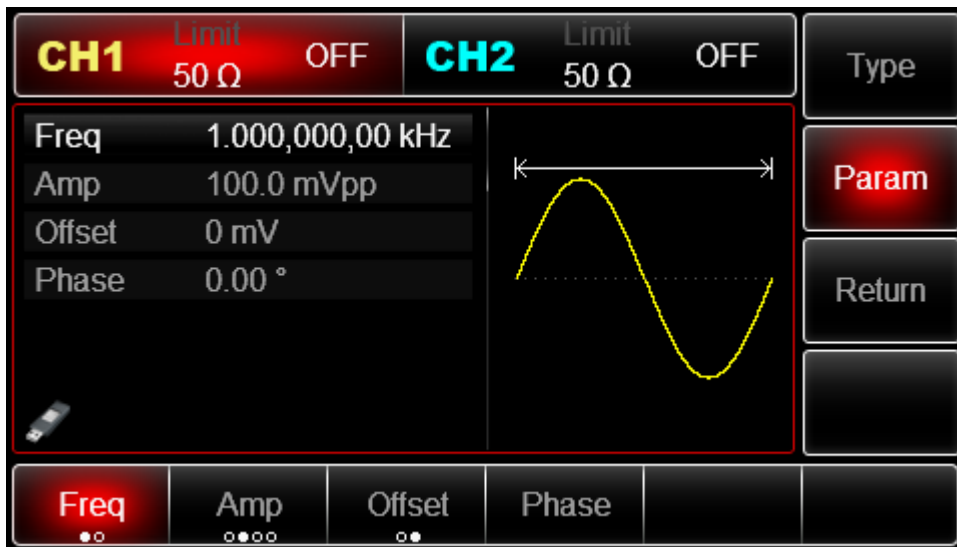

Press corresponding soft key first, then enter required numerical value, and select the unit.

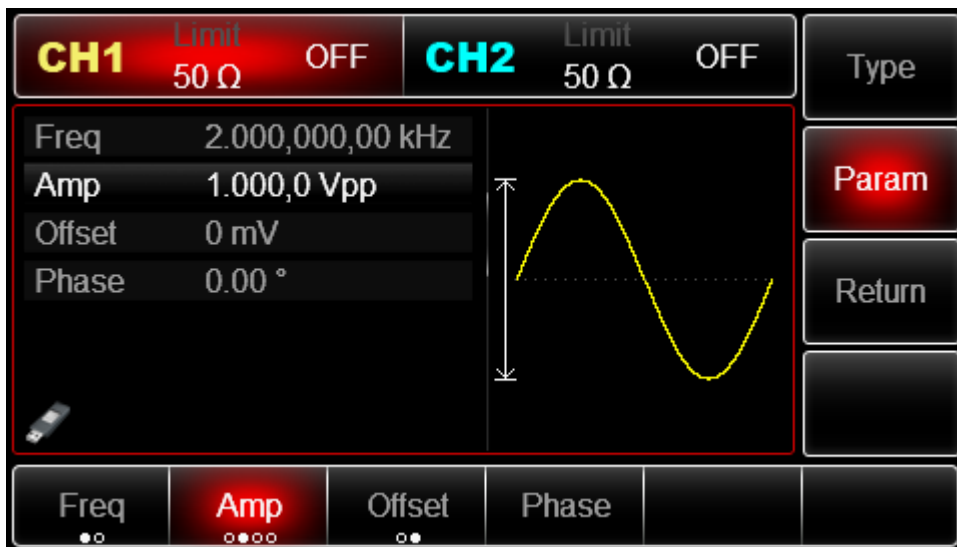

Set Hop Frequency and FSK Rate

Press **Return** soft key to go back to the following interface.

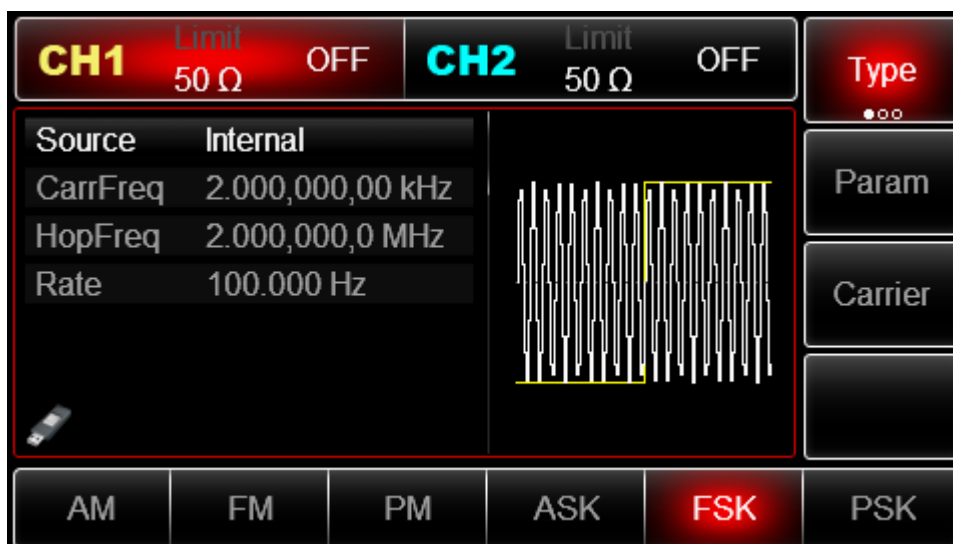

Press **Param** soft key again, and the interface will pop up as following

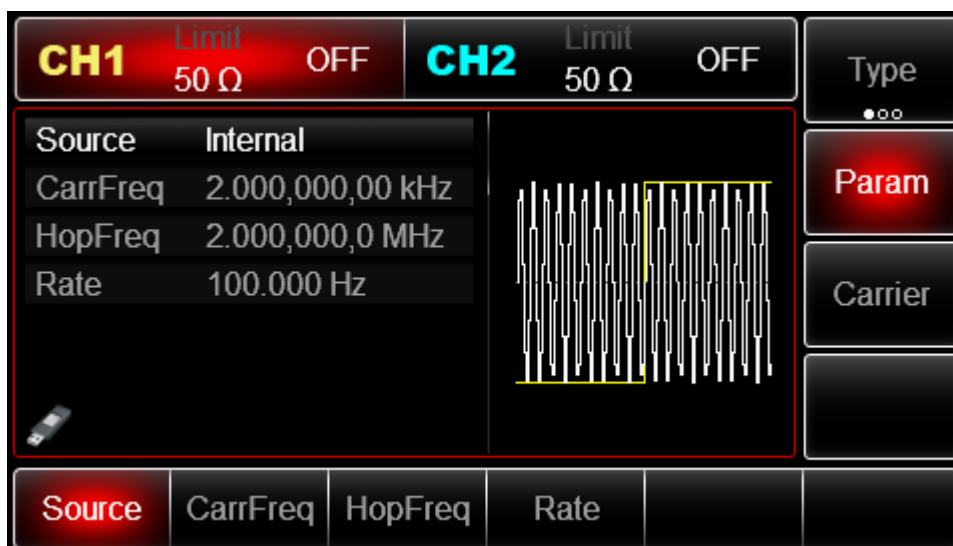

Press corresponding soft key first, then enter required numerical value, and select the unit.

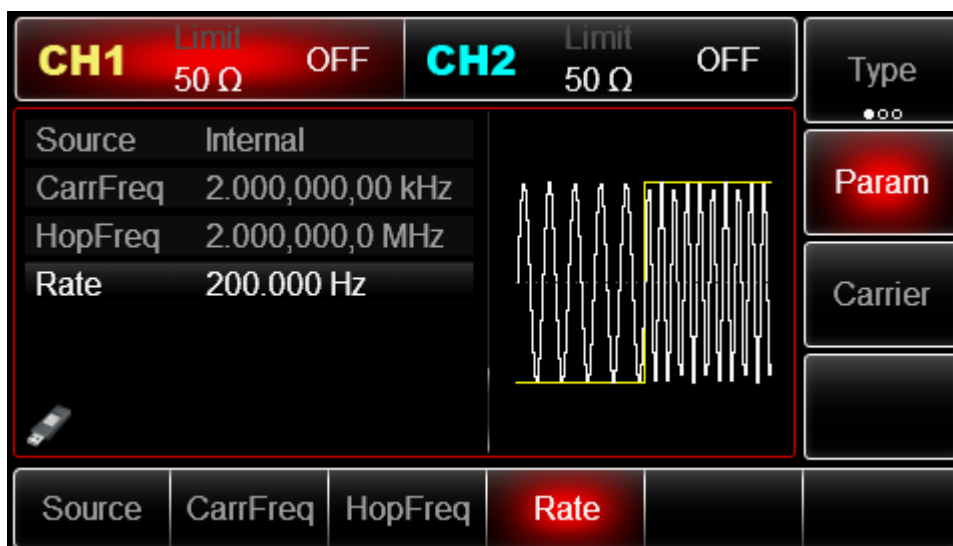

Enable Channel Output

Press **CH1** button start channel 1 output quickly. Or enable output by pressing **Utility** and then **CH1**

[Setting]. After channel output is opened, backlight of [CH1] button is on, and on the right side of channel information label, the font “OFF” changes to “FSK”, meaning open channel output.

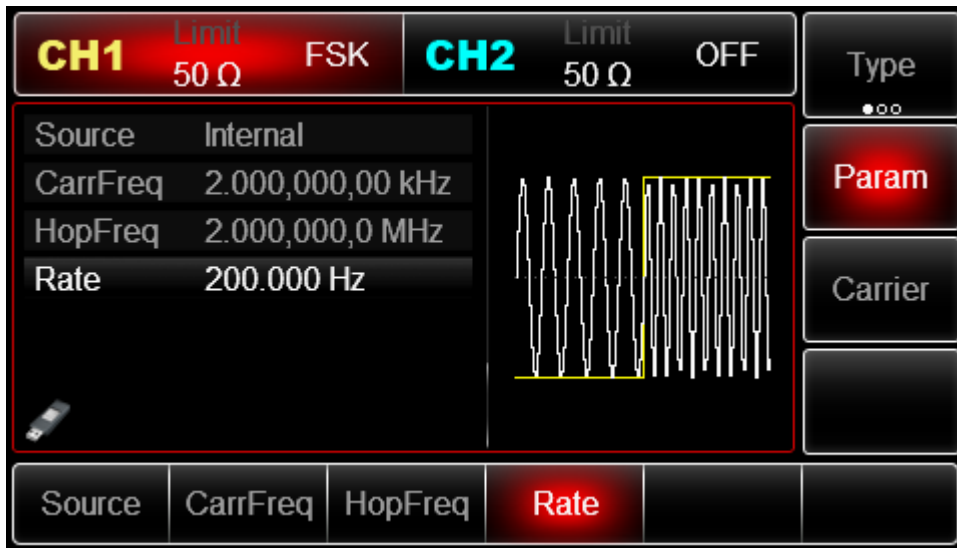

The shape of FSK modulation waveform checked through oscilloscope is shown as following:

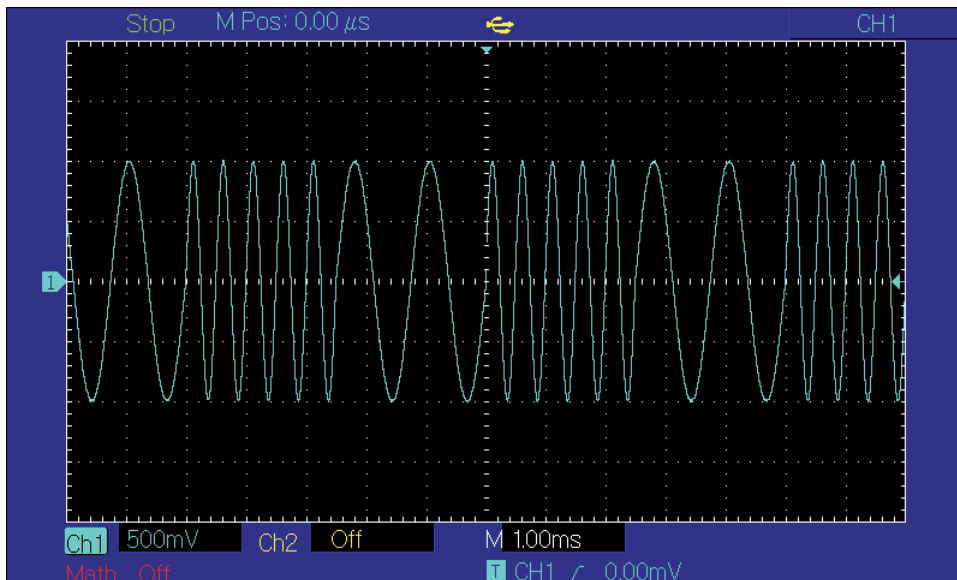

### 3.1.6 Phase Shift Keying (PSK)

In phase shift keying, DDS function generator can be configured to move between two preset phase (carrier wave phase and modulation phase). Output carrier wave signal phase or hop signal phase on the basis of the logic of modulation signal.

#### PSK Modulation Selection

Press [Menu] → [Mod] → [Type] → [PSK] in turn to start the PSK function. The device will output modulated waveform with carrier wave phase (the default is 0° and is not adjustable) of current setting and modulation phase.

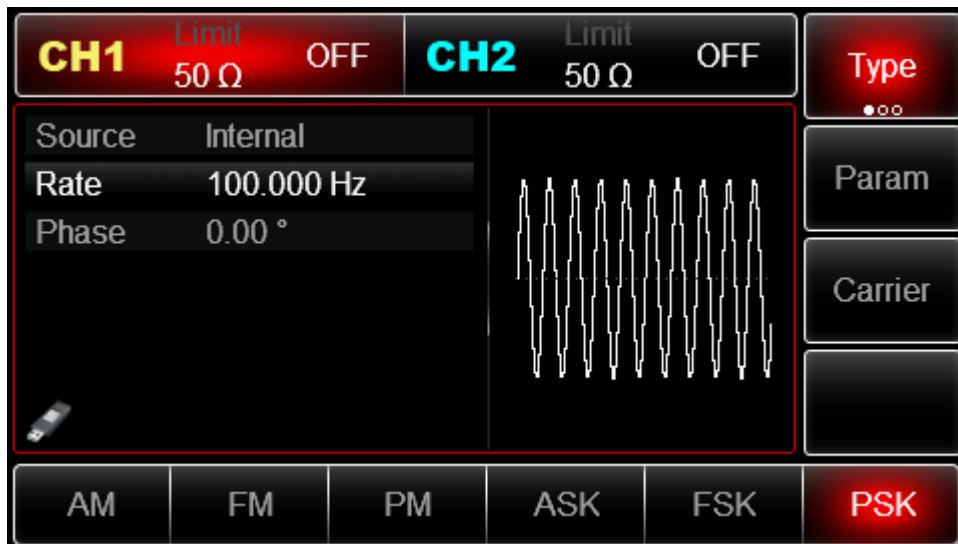

Carrier Wave Waveform Selection

PSK carrier waveform can be: Sine wave, square, ramp wave or arbitrary wave (except DC), and the default is sine wave. Press **Carrier** soft key to enter carrier waveform selection interface.

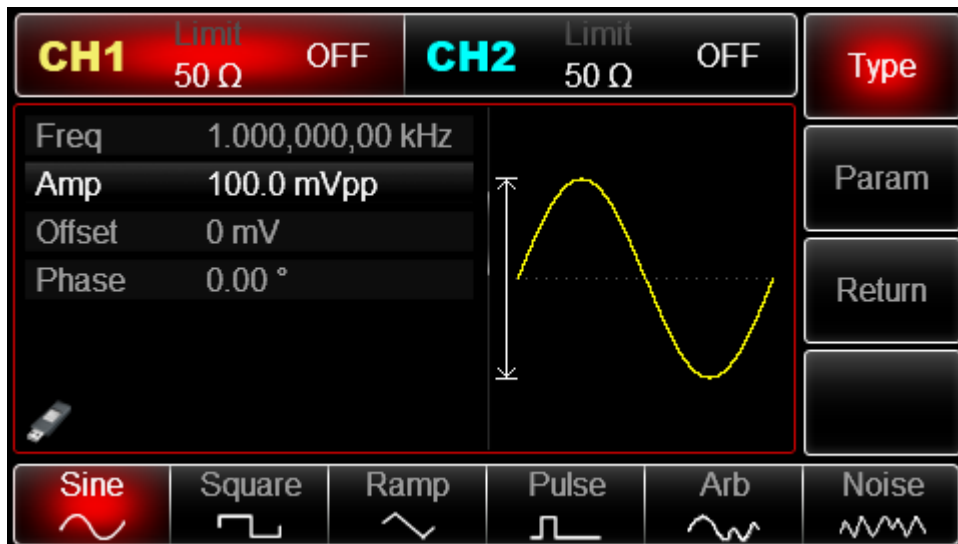

Carrier Wave Frequency Setting

See Carrier Wave Frequency Setting

Modulation Source Selection

UTG2000B function/arbitrary waveform generator can select internal modulation source or external modulation source. After enabling PSK function, the default of modulation source is internal. If need to change, press **Param** → **Source** → **External** in turn.

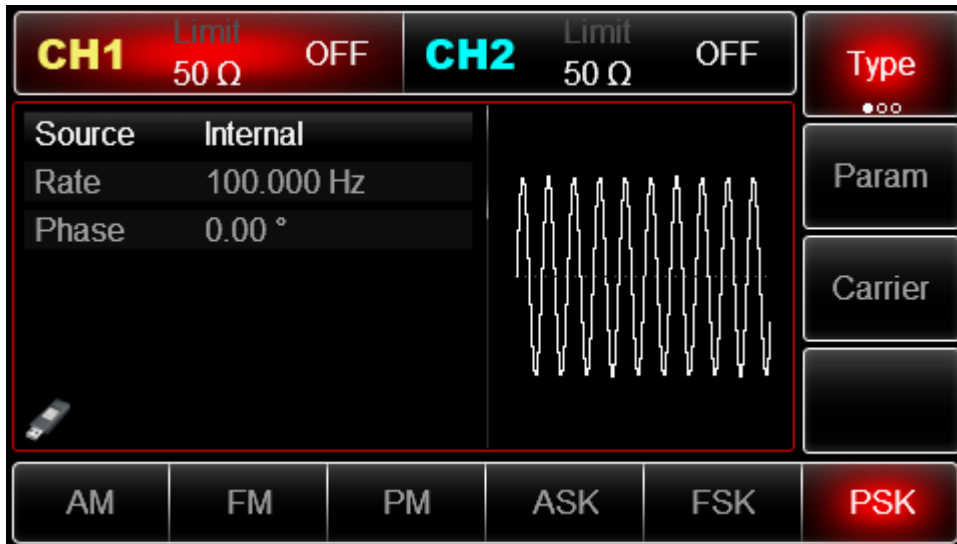

1) Internal Source

When modulation source is internal, internal modulation wave is a square wave of 50% duty ratio (not adjustable). The PSK rate can be set to customize the moving frequency between carrier wave phase and modulation phase.

2) External Source

When modulation source is external, carrier waveform will be modulated by an external waveform. Carrier wave phase will be output when external input logic is low, and modulation phase will be output when external input logic is high.

PSK Rate Setting

When modulation source is internal, the moving frequency between carrier wave phase and modulation phase can be set. After enabling PSK function, PSK rate can be set and the settable range is 2mHz to 1MHz, the default rate is 100Hz. If need to change, press

**Param** → **Rate** in turn.

Modulation Phase Setting

Modulation phase indicates the change between the phases of PSK modulated waveform and the phase of carrier wave phase. Settable range of PSK phase is from 0° to 360°, and the default value is 180°. If need to change, press **Param** → **Phase** in turn.

Comprehensive Example

Make the instrument work in phase shift keying (PSK) mode, then set a sine wave with 2kHz and 2Vpp from the internal of the instrument as a carrier wave signal, finally, make carrier wave phase and modulation phase move between each other with 1kHz frequency. Specific steps are seen as following:

Enable Phase Shift Keying (PSK) Function

Press **Menu** → **Mod** → **Type** → **PSK** in turn to start the PSK function.

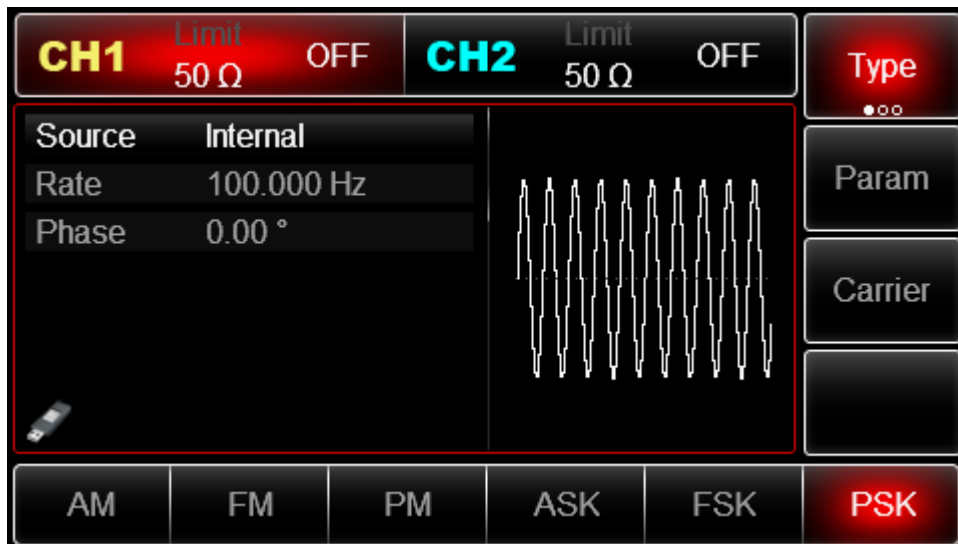

Set Carrier Wave Signal Parameter

Press **Carrier** → **Type** → **Sine** in turn to select sine wave as carrier wave signal.

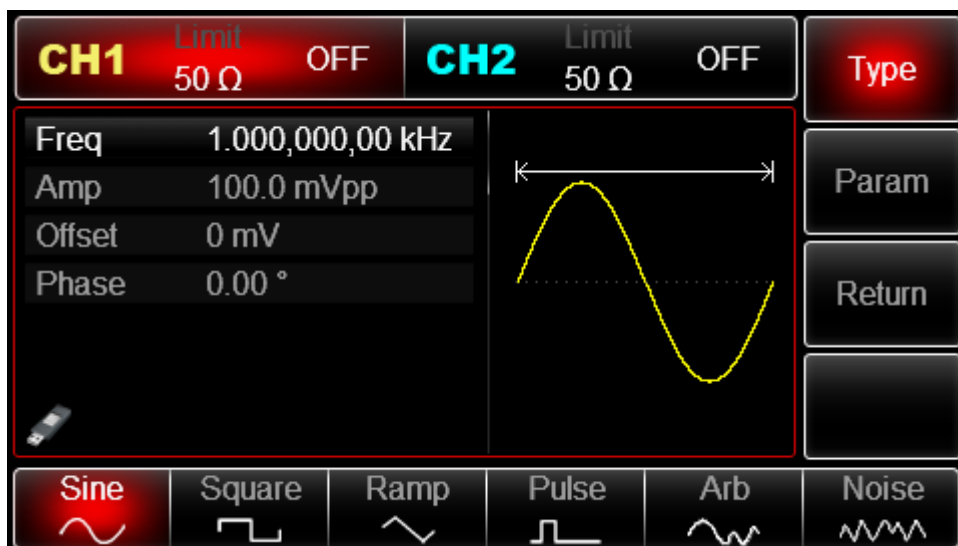

Press **Param** soft key, and the interface will pop up as following:

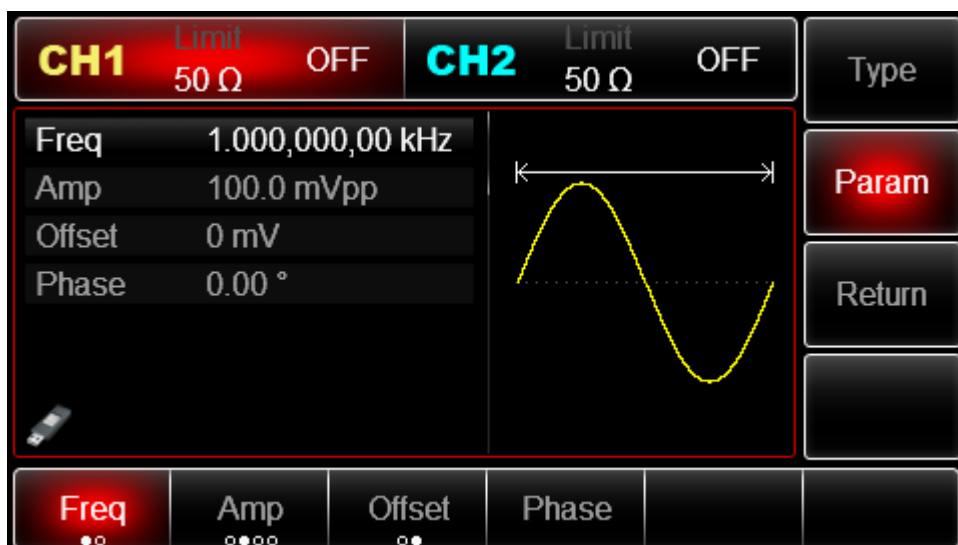

Press corresponding soft key, then enter required numerical value, and select the unit.

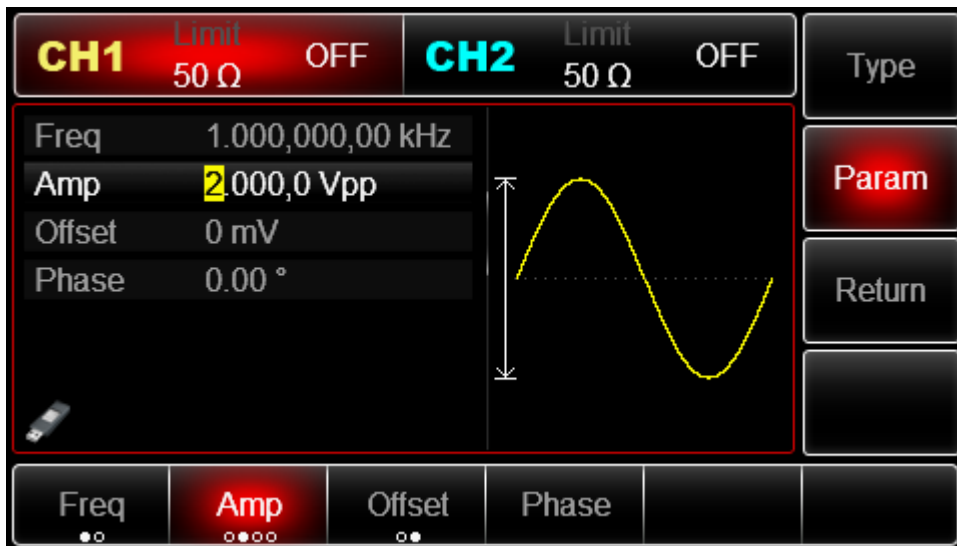

Set PSK Rate and Modulation Phase

Press **Return** soft key to go back to the following interface:

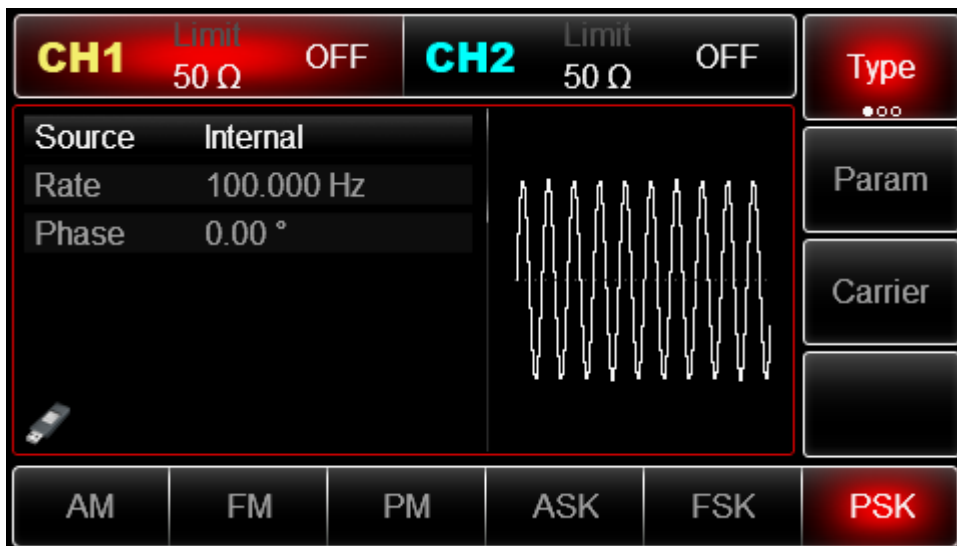

Press **Param** soft key, and the interface will pop up as following:

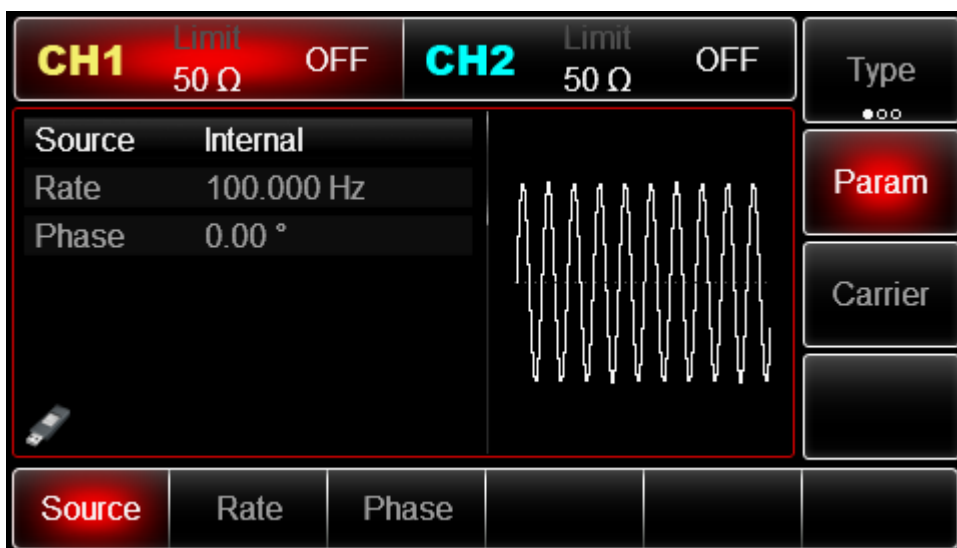

Press corresponding soft key, then enter required numerical value, and select the unit.

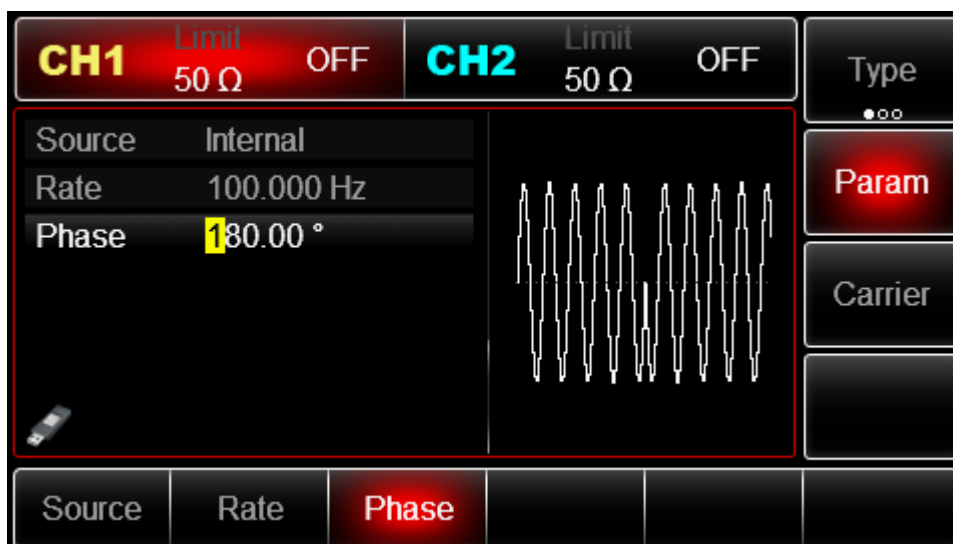

Enable Channel Output

Press **CH1** button start channel 1 output quickly. Or enable output by pressing **Utility** and then **CH1 Setting**. After channel output is opened, backlight of **CH1** button is on, and on the right side of channel information label, the font “OFF” changes to “PSK”, meaning open channel output.

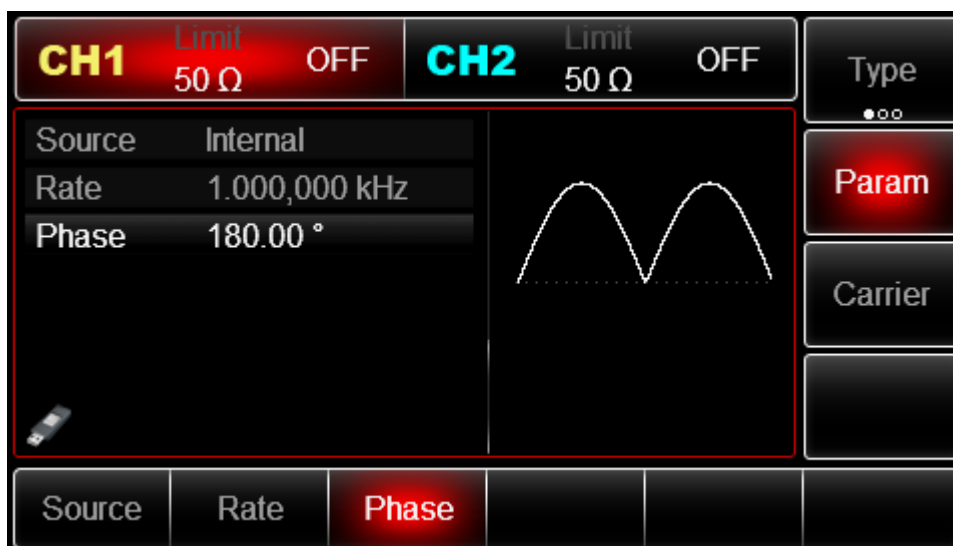

The shape of PSK modulation waveform checked through oscilloscope is shown as following:

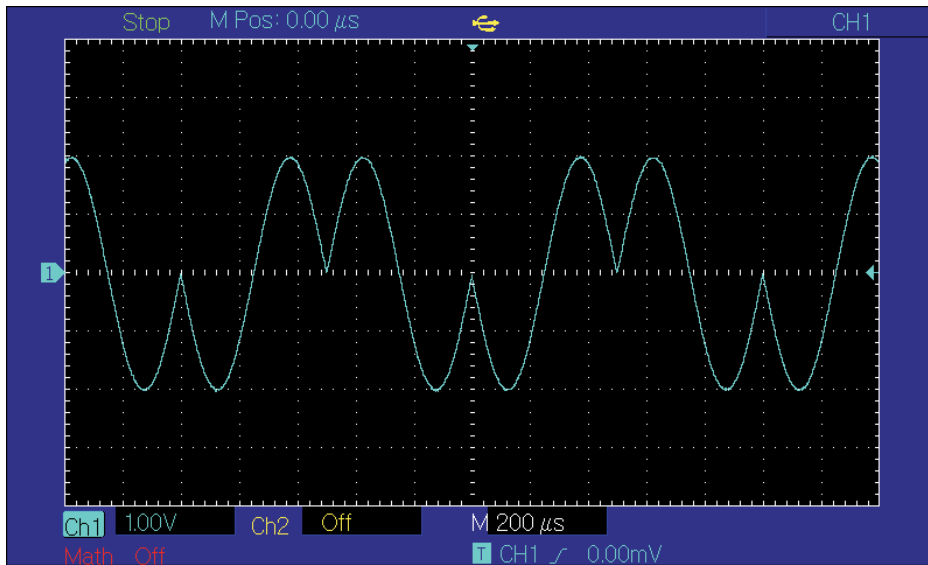

### 3.1.7 Binary Phase Shift Keying (BPSK)

The function/arbitrary waveform generator can move between two preset phases (carrier phase and modulation phase) in binary phase shift keying, expressing 0 and 1. Phase of carrier signal or modulation signal is output according to logic of modulation signal. The modulation mode of the two channels is mutually independent. You can configure same or different modulation mode for channel 1 and 2.

Select BPSK modulation

Press **Menu** → **Mod** → **Type** → **BPSK** successively to use BPSK function (if **Type** is not highlighted, press soft key **Type** to select). After BPSK function is enabled, UTG2000B function/arbitrary waveform generator will output modulated waveform with the current carrier phase (0° by default and unadjustable) and modulation phase.

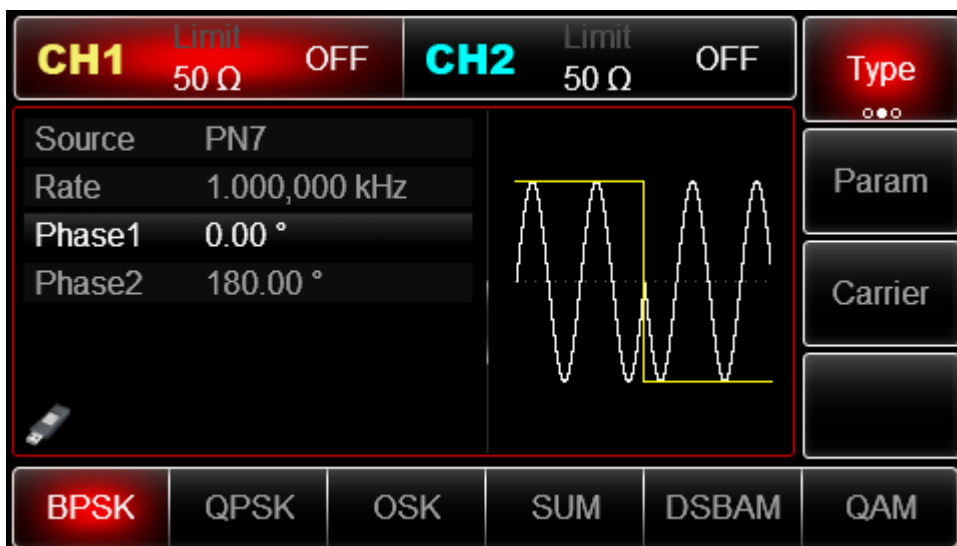

Select carrier waveform

BPSK carrier waveform can be sine wave, square wave, ramp wave or arbitrary wave (except DC), and is sine wave by default. After PSK modulation is selected, press Carrier Parameter to select carrier waveform.

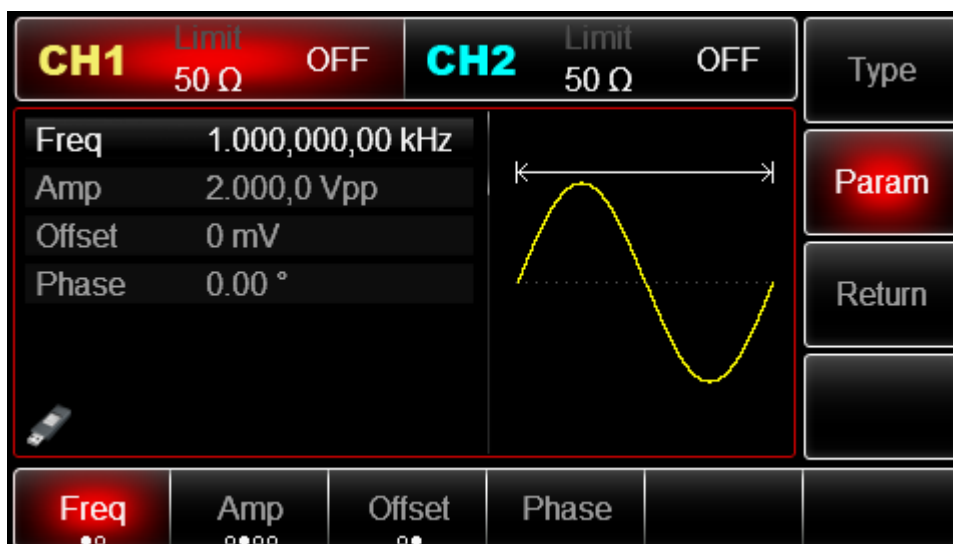

Set carrier frequency

See Carrier Frequency Wave Setting

Select modulation source

UTG2000B function/arbitrary waveform generator can select internal or external modulation source. After you enable BPSK function, you can see that modulation source is PN7 by default. You can change it with multi-functional knob on the interface for using PSK function

or by pressing soft key **Param** → **Source**.

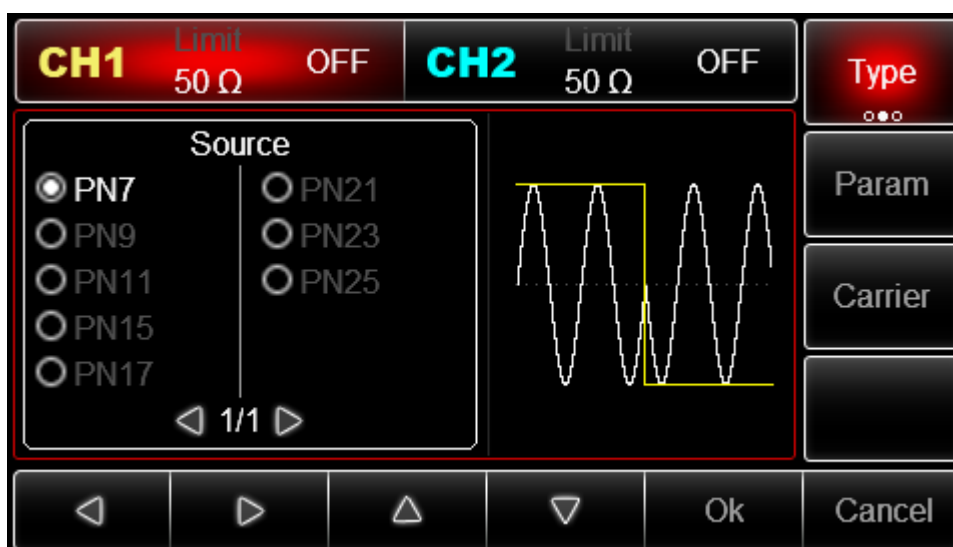

Set BPSK rate

The frequency between carrier phase and modulation phase can be set. After you use BPSK function, you can set BPSK rate, which is in the range of 2mHz~1MHz and 100Hz by default. You can change it with multi-functional knob and direction key on the interface

for using PSK function or by pressing **Param** → **Rate**. Set modulation phase

Modulation phase is change in phase of waveform subject to PSK modulation relative to

carrier phase. The range of BPSK modulation phase is 0°~360°. You can change it with multi-functional knob and direction key on interface for using PSK function or by pressing **Parameter** → **Phase2**.

Comprehensive example

First make the instrument run in BPSK mode, and then set an internal sine wave of 2kHz and 2Vpp as carrier signal. Finally set carrier phase and initial modulation phase to be  $90^\circ$ , frequency between phases to be 1kHz and PN code to be PN15. The specific steps are as follows:

Use BPSK function

Press **Menu** → **Type** → **BPSK** successively (press soft key **Type** to select if **Type** is not highlighted) to use BPSK function.

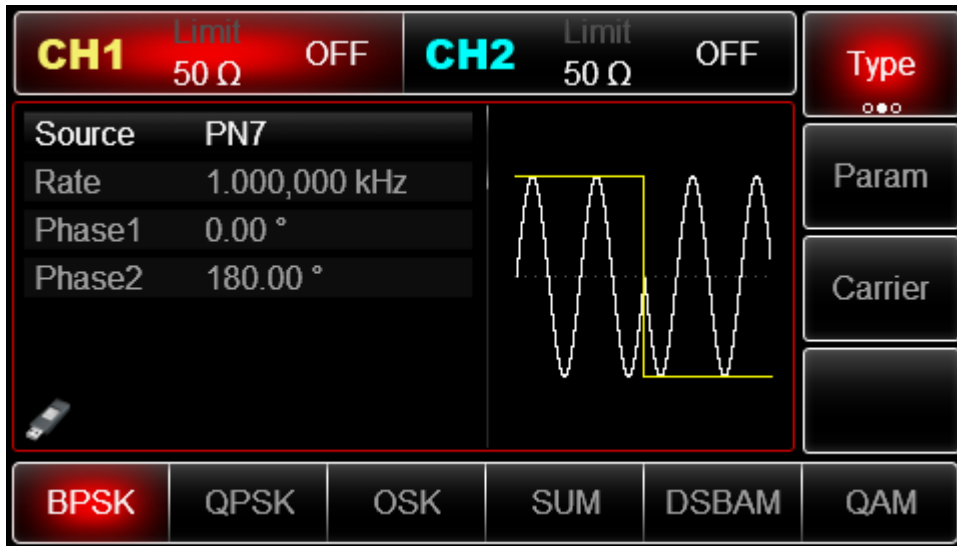

Set carrier signal parameters

Press **Carrier** → **Type** → **Sine** to select carrier signal as sine wave. The default carrier signal is sine wave, so it is unnecessary to change in this example.

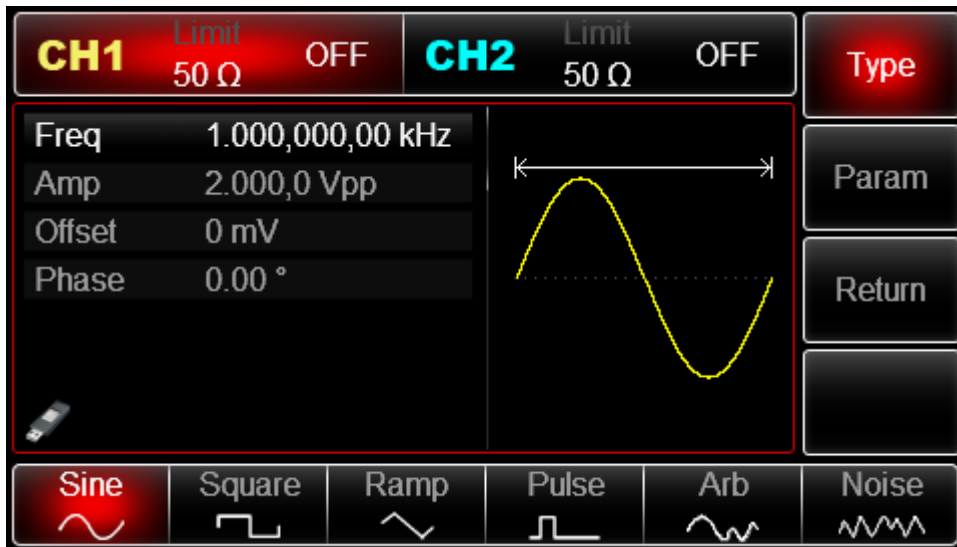

You can press **Param** to setup the parameters.

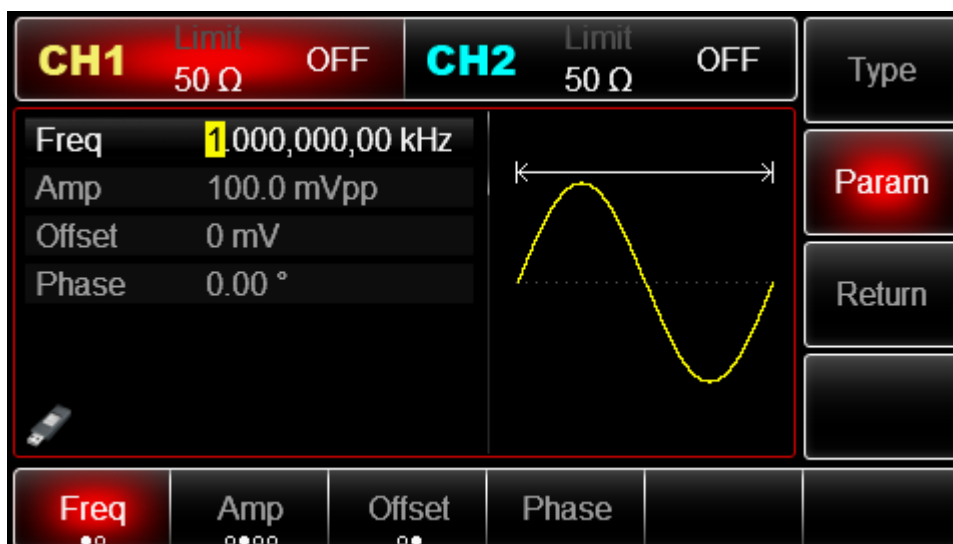

If you need to set up the parameter, input the value and then select the unit.

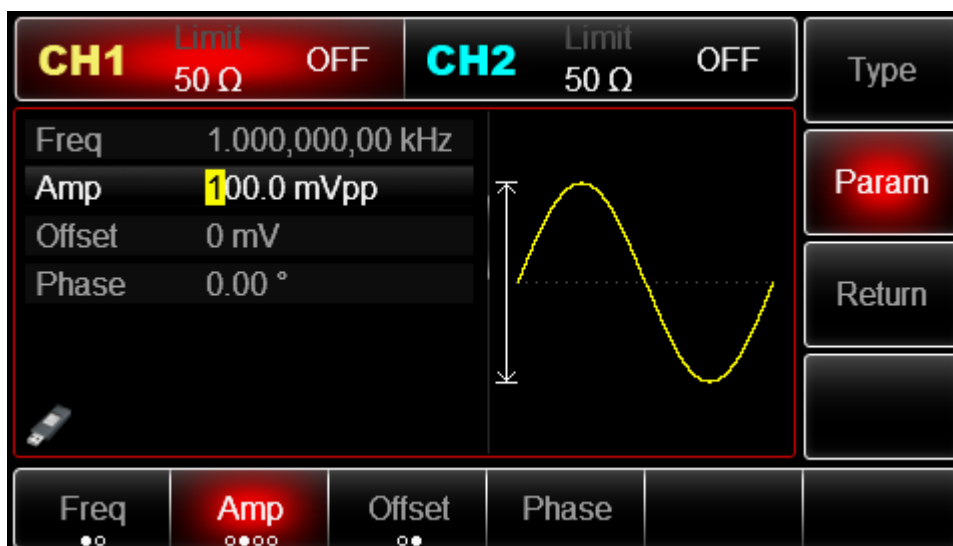

Set BPSK rate, modulation phase and PN code

Press **Return** to return to the interface below after setting carrier parameters:

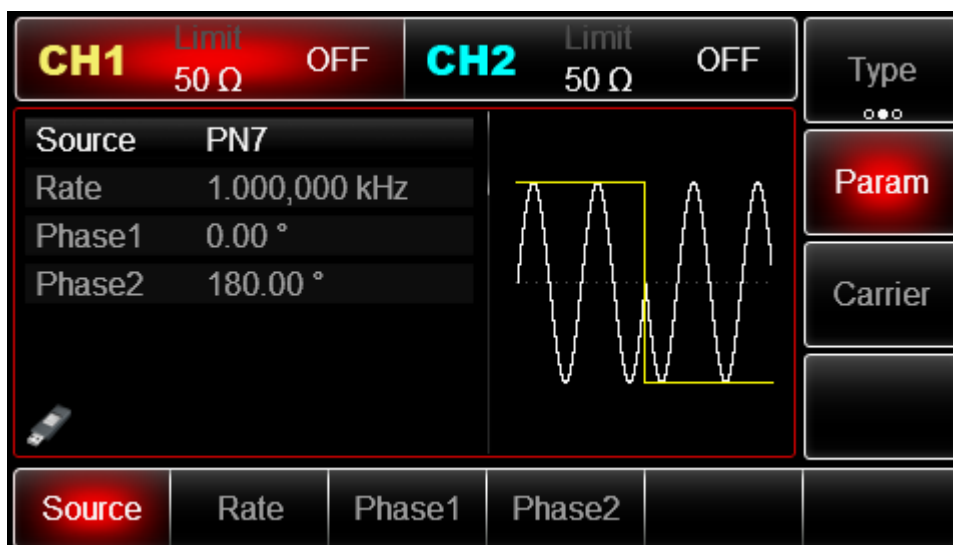

To set some parameter, press corresponding soft key, input the required value and select the unit.

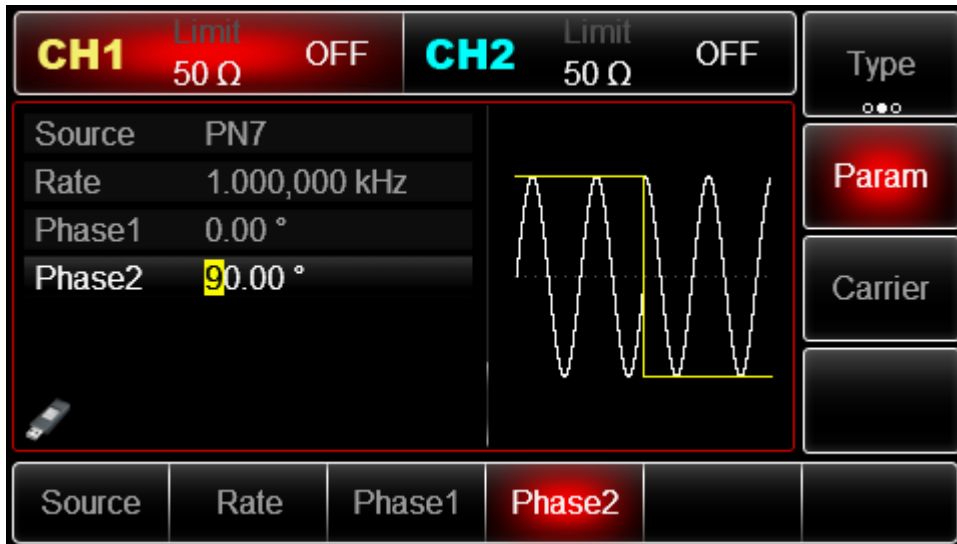

Enable channel output

Press **CH1** button start channel 1 output quickly. Or enable output by pressing **Utility** and then **CH1 Setting**. After channel output is opened, backlight of **CH1** button is on, and on the right side of channel information label, the font “OFF” changes to “BPSK”, meaning open channel output.

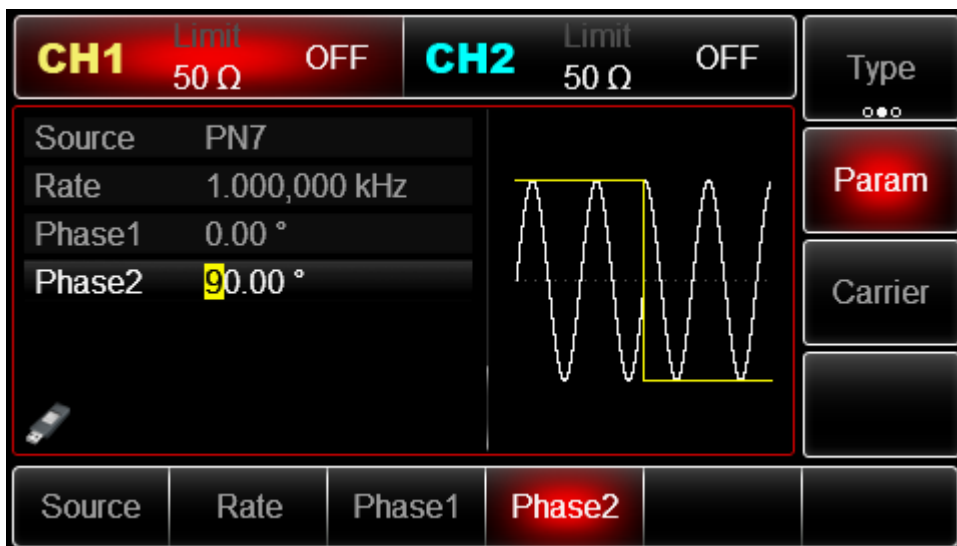

Check the shape of BPSK modulation waveform through oscilloscope, which is shown in the figure below:

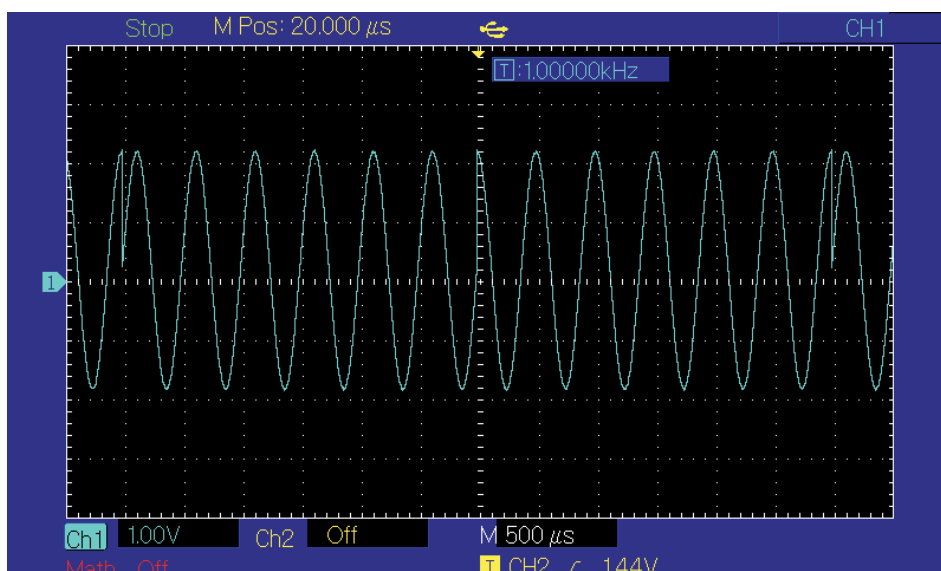

### 3.1.8 Quadrature Phase Shift Keying(QPSK)

The function/arbitrary waveform generator can move between four preset phases (carrier phase and 3 modulation phases). Phase of carrier signal or modulation signal is output according to logic of modulation signal. The modulation mode of the two channels is mutually independent. You can configure same or different modulation mode for channel 1 and 2.

Select QPSK modulation

Press **Menu** → **Mod** → **Type** → **QPSK** to enable QPSK function (if **Type** is not highlighted, press soft key **Type** to select). After QPSK function is used, UTG2000B function/arbitrary waveform generator will output modulated waveform with the current carrier phase and modulation phase.

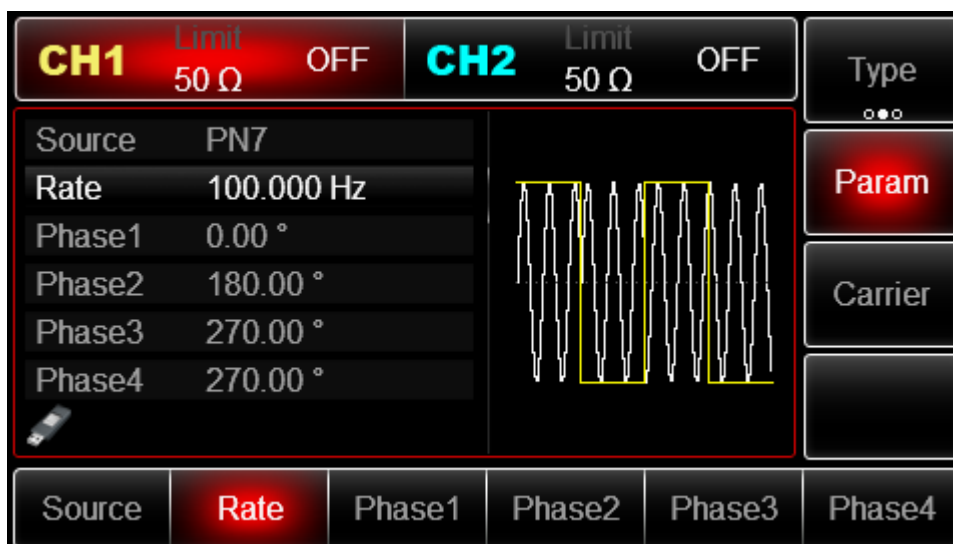

Select carrier waveform

QPSK carrier waveform can be sine wave, square wave, saw tooth wave or arbitrary wave (except DC), and is sine wave by default. After QPSK modulation is selected, press Carrier to select carrier waveform.

### 3.1.9 Oscillation Keying(OSK)

The function/arbitrary waveform generator can output a sinusoidal signal of intermittent oscillation in OSK. Carrier waveform is output when internal crystal oscillator starts oscillation; output is stopped when internal crystal oscillator stops oscillation. The modulation mode of the two channels is mutually independent. You can configure same or different modulation mode for channel 1 and 2.

Select OSK modulation

Press **Menu** → **Mod** → **Type** → **OSK** to use BPSK function (if **Type** is not highlighted, press soft key **Type** to select). After OSK function is used, UTG2000B function/arbitrary waveform generator will output modulated waveform with the current carrier wave and modulation wave.

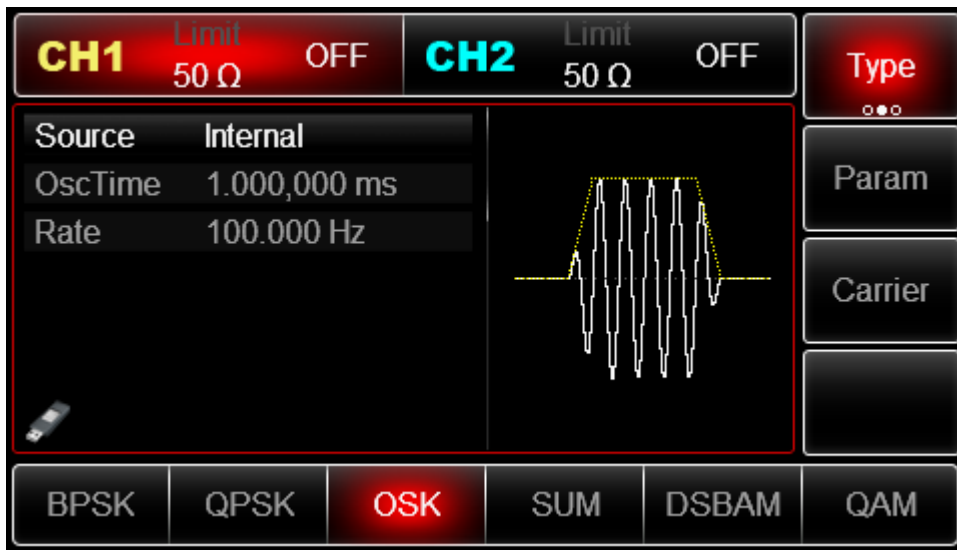

Select carrier waveform

OSK carrier waveform is sine wave.

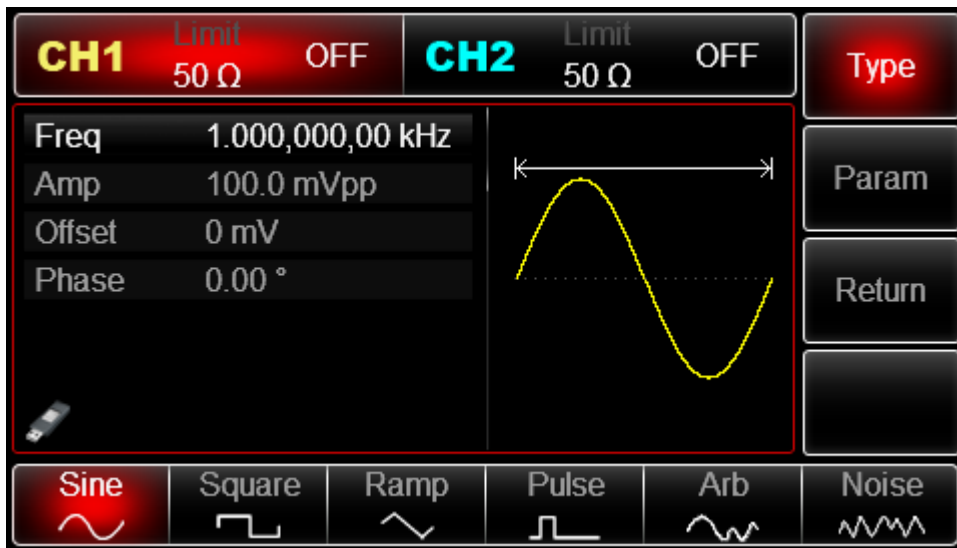
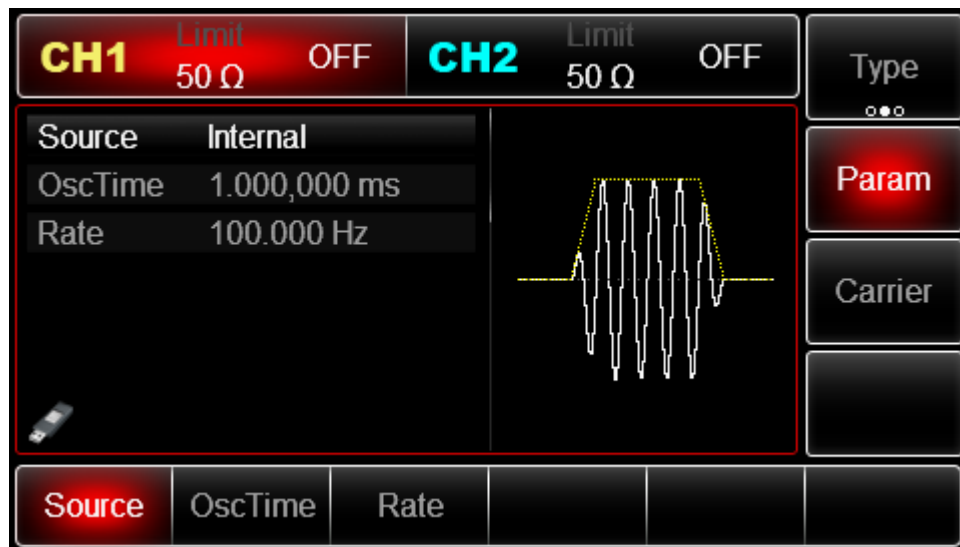

Figure 3 - 1 Select carrier waveform Set carrier frequency

See Carrier Frequency Wave Setting Select modulation source

UTG2000B function/arbitrary waveform generator can select internal or external modulation source. After

you use PSK function, you can see that modulation source is internal by default. You can change it with multi-functional knob on the interface for using PSK function or by pressing **Param** → **Source**



#### 1) Internal source

In case of internal modulation source, internal modulation wave is sine wave. The phase relation between oscillation start and stop can be designated by setting OSK rate.

#### 2) External source

In case of external modulation source, rate will be hidden in parameter list, when an external waveform will be used to modulate carrier waveform. OSK output phase is determined by logic level on external digital modulation interface (FSK Trig connector). For example, when external input logic is low, carrier phase is output; when external input logic is high, modulation phase is output.

Set vibrate time

Press the soft key and enter the period value. Range: 8ns~200ns, default is 1ms. Set OSK rate

The frequency between carrier phase and modulation phase can be set in case of internal modulation source. After you use OSK function, you can set QPSK rate, which is in the range of 2mHz~1MHz and 100Hz by default. You can change it with multi-functional knob and direction key on the interface for using PSK function or by pressing **Rate**.

Comprehensive example

First make the instrument run in OSK mode, and then set an internal sine wave of 2kHz and 2Vpp as carrier signal. Set rate to be 100Hz and oscillation period to be 1μs. The specific steps are as follows:

#### (1) OSK function

Press **Mod** → **Type** → **OSK** successively (press soft key **Type** to select if **Type** is not highlighted) to use OSK function.

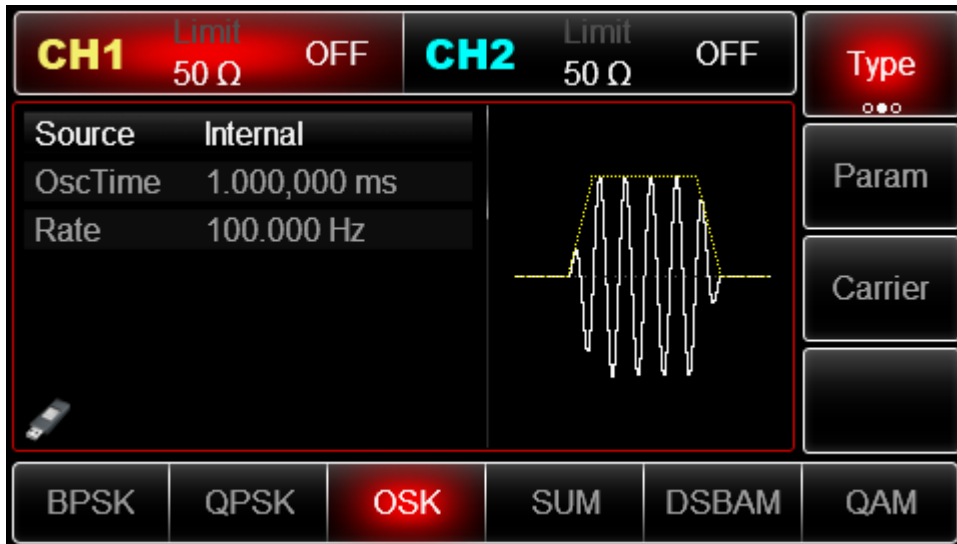

(2) Set carrier signal parameters

Press **Carrier** → **Type** → **Sine** to select carrier signal as sine wave. The default carrier signal is sine wave, so it is unnecessary to change in this example. You can set with multi-functional knob and direction key. You can also press corresponding soft keys of function again, when the interface below will pop up. To set some parameter, press corresponding soft key, input the required value and select the unit.

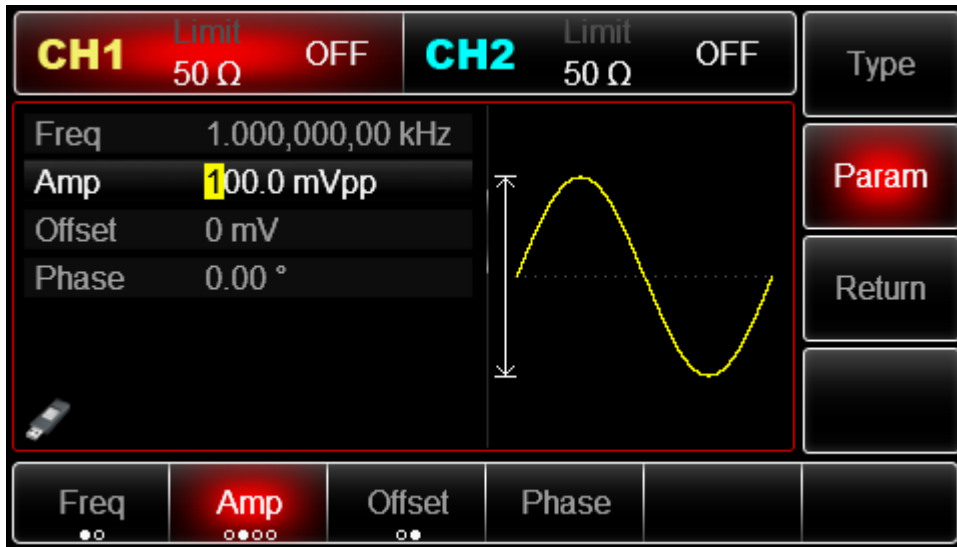

(3) Set OSK rate, modulation phase and PN code

Press **Return** to return to the interface below after setting carrier parameters:

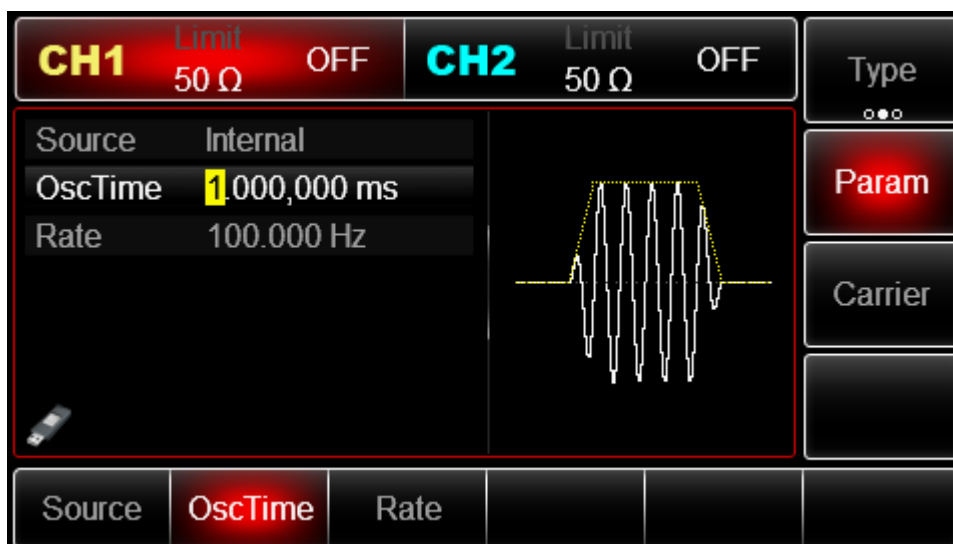

You can set with multi-functional knob and direction key directly on this interface. You can also press corresponding soft keys of function again, when the interface below will pop up. To set some parameter, press corresponding soft key, input the required value and select the unit.

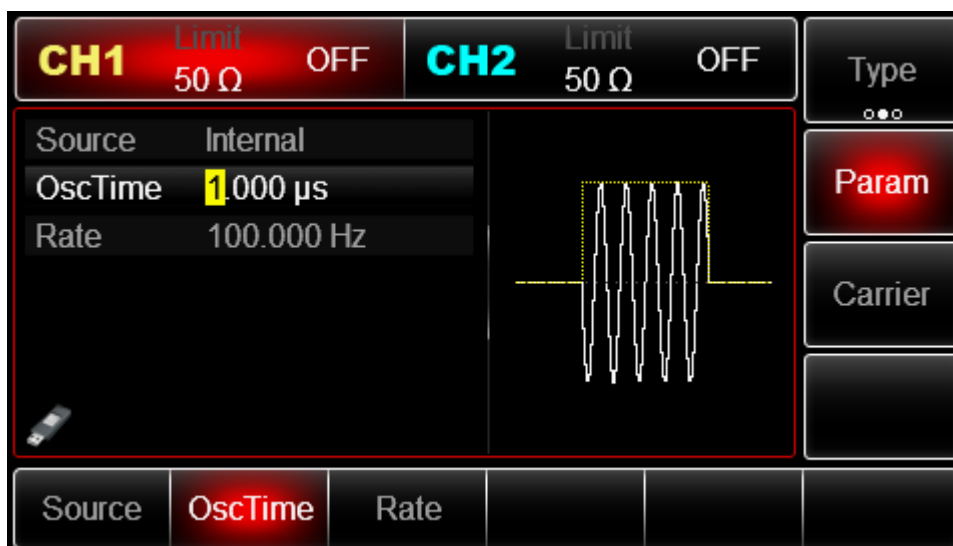

Figure 3 - 2 Set modulation rate

(4) Use channel output

Press **CH1** button start channel 1 output quickly. Or enable output by pressing **Utility** and then **CH1 Setting**. After channel output is opened, backlight of **CH1** button is on, and on the right side of channel information label, the font "OFF" changes to "OSK", meaning open channel output.

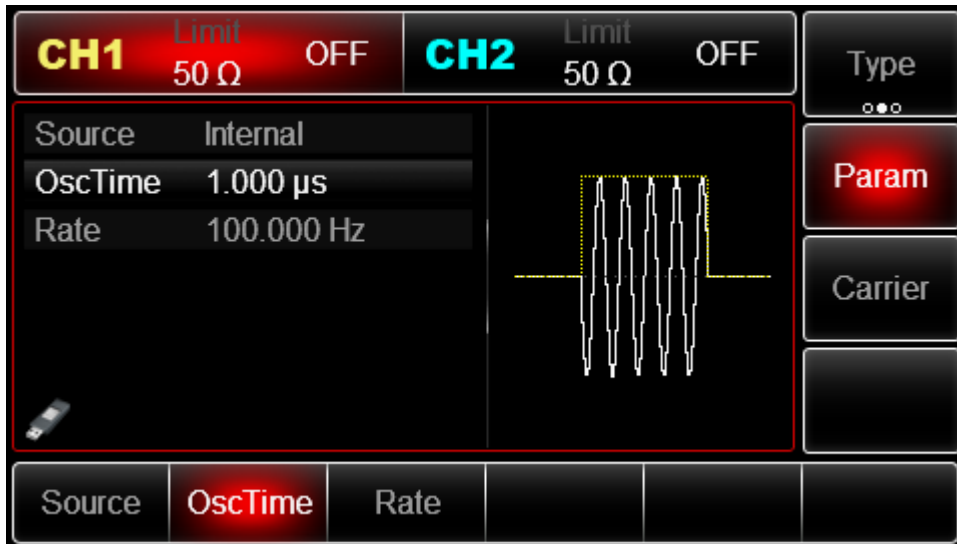

Figure 3 - 3 Use channel output

Check the shape of OSK modulation waveform through oscilloscope, which is shown in the figure below:

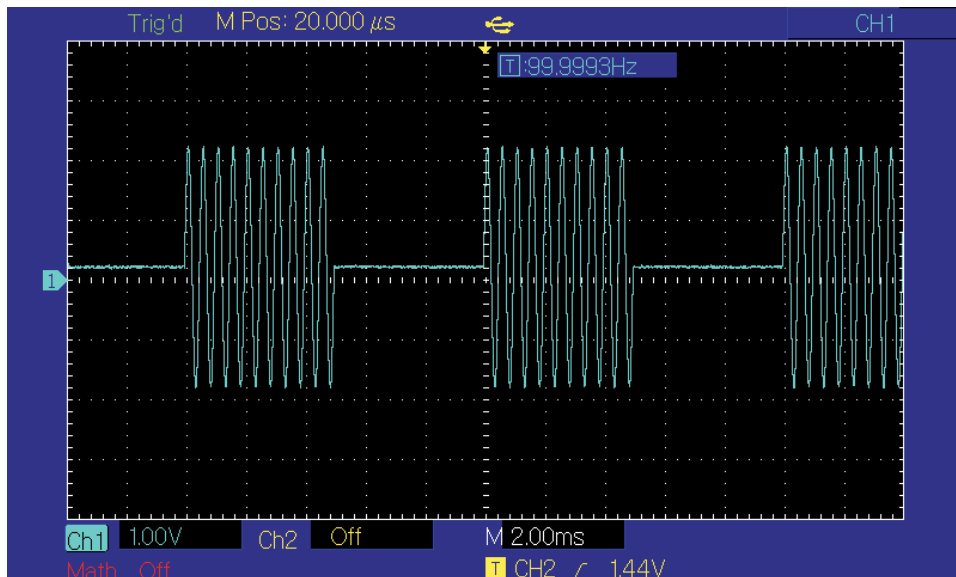

Figure 3 - 4 OSK waveform with oscilloscope

### 3.1.10 Sum Modulation(SUM)

In SUM, the modulated waveform generally is composed of carrier wave and modulation wave. The output waveform is obtained by the sum of product of carrier amplitude and modulation factor and product of amplitude of modulation wave and modulation factor.

The modulation mode of the two channels is mutually independent. You can configure same or different modulation mode for channel 1 and 2.

Select SUM

Press **Menu** → **Type** → **SUM** successively to use SUM function (if **Type** is not highlighted, press soft key **Type** to select). After SUM function is used, UTG2000B function/arbitrary waveform generator will output modulated waveform with the current modulation waveform and carrier wave.

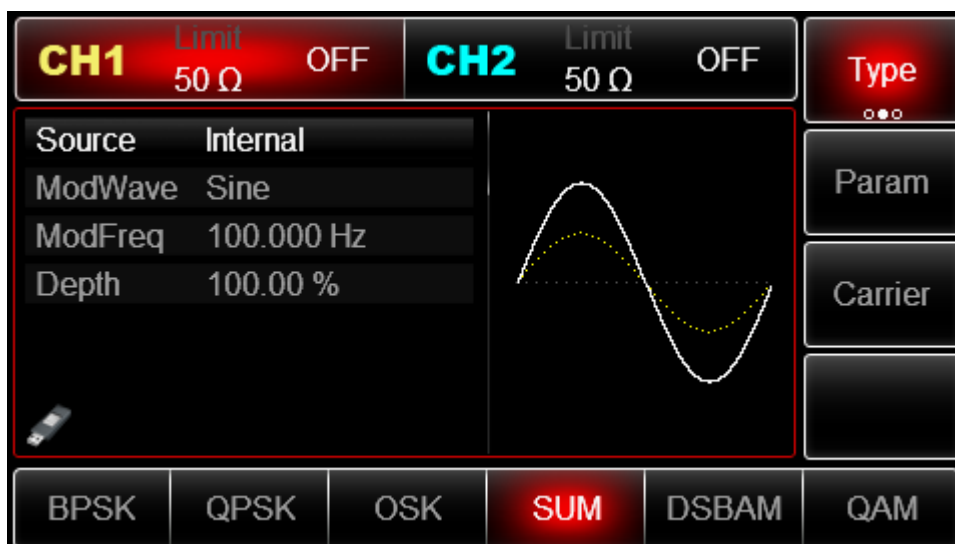

Figure 3 - 5 Select SUM function

Select carrier waveform

SUM carrier waveform can be sine wave, square wave, ramp wave or arbitrary wave (except DC), and is sine wave by default. After SUM is selected, press the key of basic waveform setting to quickly set corresponding carrier waveform.

Set carrier frequency

See Carrier wave frequency setting Select modulation source

UTG2000B function/arbitrary waveform generator can select internal or external modulation source.

After you use SUM function, you can see that modulation source is internal by default. You can change it with multi-functional knob on the interface for using SUM function

or by pressing **Param** → **Source**

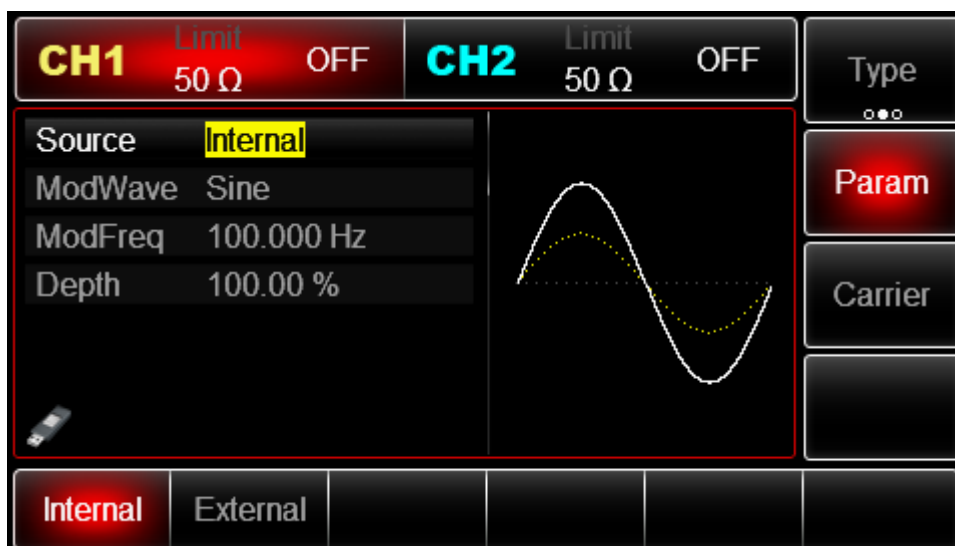

Figure 3 - 6 Select modulation source

1) Internal source

In case of internal modulation source, modulation wave can be sine wave, square wave, rising ramp wave, falling ramp wave, arbitrary wave and noise, and is sine wave by default. After you use SUM function, you can see that modulation wave is sine wave by default. You can change it with multi-functional knob on interface for using amplitude modulation function or by pressing **Param**

→ **ModWave**

- ModWave Square wave: duty ratio is 50%
- Rising ramp wave: symmetry degree is 100%
- Falling ramp wave: symmetry degree is 0%
- Arbitrary wave: when selecting arbitrary wave as modulation waveform, function/arbitrary waveform generator limits length of arbitrary wave to 4kpts by automatic test count. Noise: white
- Gaussian noise

## 2) External source

In case of external modulation source, modulation wave and frequency will be hidden in parameter list, when an external waveform will be used to modulate carrier waveform.

SUM depth is controlled by  $\pm 5V$  signal level on external analog modulation input terminal (Modulation In connector) of back panel. For example, if modulation depth in parameter list is set to be 100%, SUM output amplitude is the maximum when external modulation signal is +5V and the minimum when external modulation signal is -5V.

### Set frequency of modulation wave

The frequency of modulation wave can be set in case of internal modulation source. After you use SUM function, you can see that default frequency of modulation wave is 100Hz. You can change it with multi-functional knob and direction key on interface for using

amplitude modulation function or by pressing **Param** → **ModFreq**. The range of modulation frequency is 2mHz~1MHz. In case of external modulation source, modulation wave and frequency will be hidden in parameter list, when an external waveform will be used to modulate carrier waveform. The frequency range of modulation signal of external input is 0Hz~20kHz.

### Set modulation depth

Modulation depth is degree of amplitude change, expressed in percentage. The range of SUM depth is 0%~100%, 100% by default. When modulation depth is 0%, carrier wave is output. When modulation depth is 100%, modulation wave is output. You can change it with multi-functional knob and direction key on interface for using amplitude modulation function or by pressing **Depth**. In case of external modulation source, the output amplitude of instrument is also controlled by  $\pm 5V$  signal level on external analog modulation input terminal (Modulation In connector) of back panel.

### Comprehensive example

First make the instrument run in SUM mode, and then set an internal sine wave of 1kHz as modulation signal and a square wave with frequency of 2kHz, amplitude of 200mVpp and duty ratio of 45% as carrier signal. Finally set modulation depth to be 80%. The specific steps are as follows:

#### (1) Use SUM function

Press **Menu** → **Mod** → **Type** → **SUM** (**Type** to select ,if **Type** is not (press soft key highlighted).

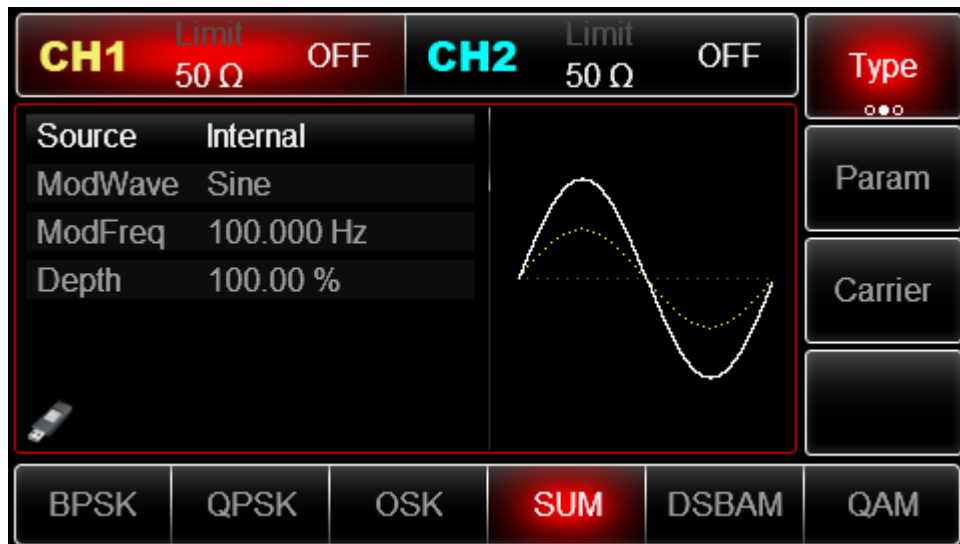

Figure 3 - 7 Select SUM function

(2) Select carrier waveform

After enabling SUM function, press **Carrier** → **Type** → **Square**. You can press **Param** again until the following interface appears.



Figure 3 - 8 Set modulation parameter

(3) Set FSK rate and modulation phase

After setting up, press **Return** to turn to the interface below:

4) Use channel output

Press **CH1** button start channel 1 output quickly. Or enable output by pressing **Utility** and then **CH1 Setting**. After channel output is opened, backlight of **CH1** button is on, and on the right side of channel information label, the font "OFF" changes to "SUM", meaning open channel output.

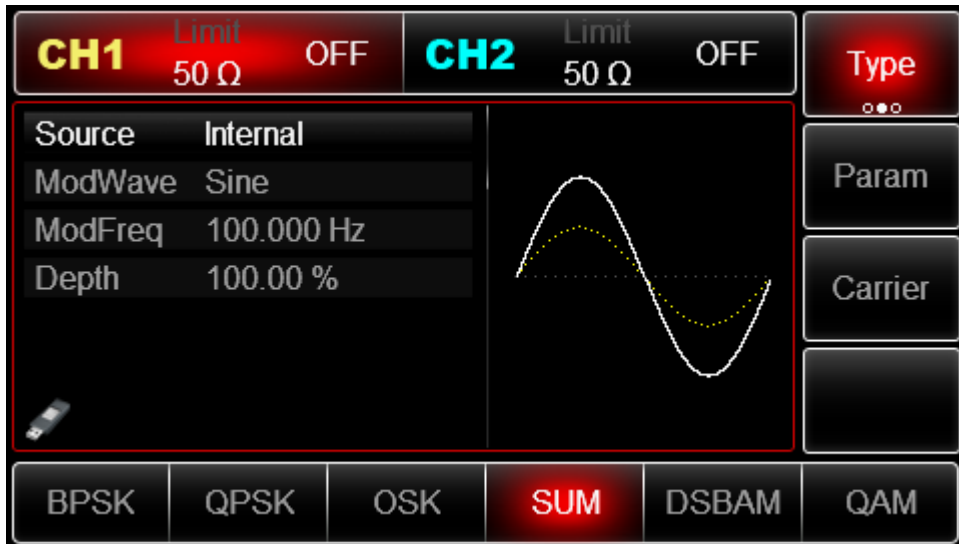

(4) Use channel output

Press CH1 button start channel 1 output quickly. Or enable output by pressing Utility and then CH1 Setting . After channel output is opened, backlight of CH1 button is on, and on the right side of channel information label, the font “OFF” changes to “SUM”, meaning open channel output.

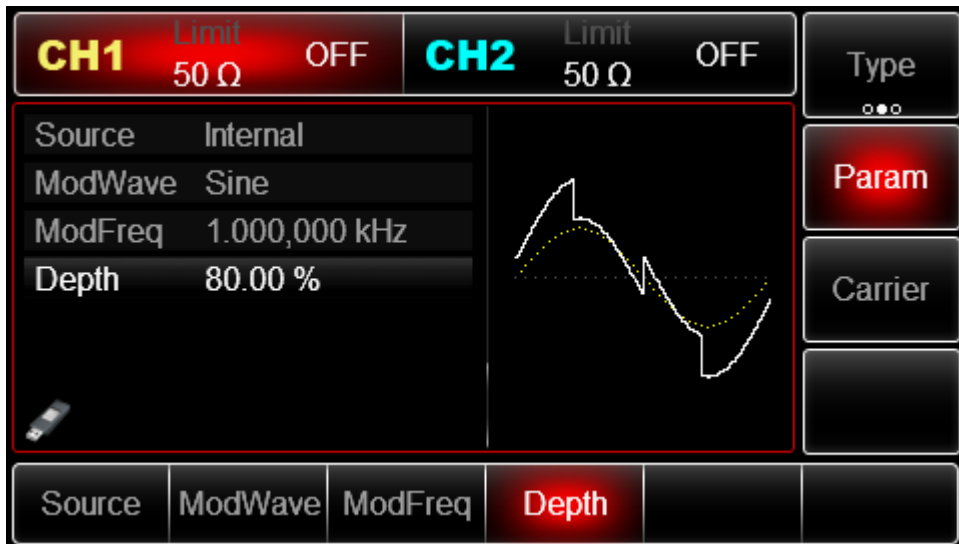
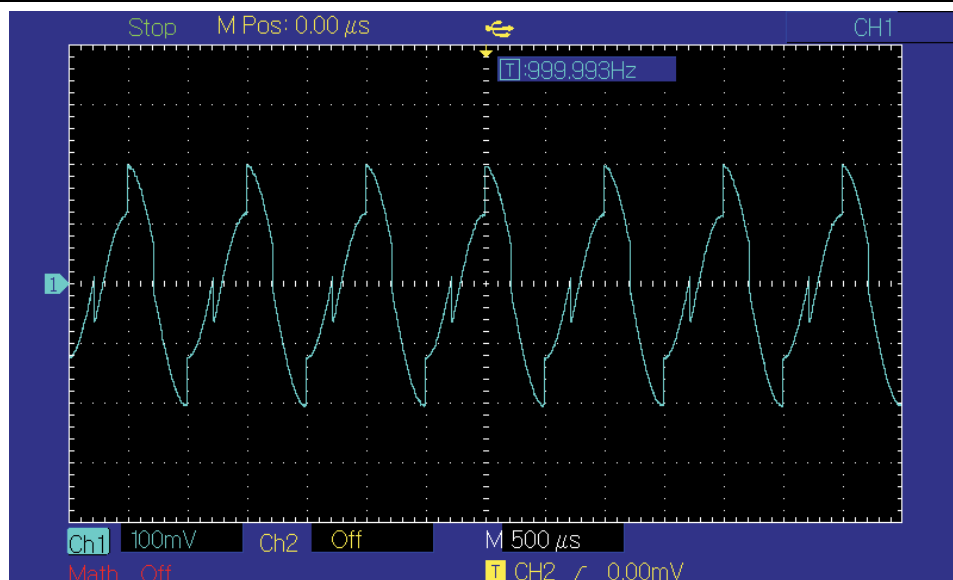

Figure 3 - 9 Use channel output

Waveform displayed on the oscilloscope



### 3.1.11 Double side band amplitude Modulation (DSBAM)

Select carrier waveform

DSBAM carrier waveform can be sine wave, square wave, ramp wave or arbitrary wave (except DC), and is sine wave by default. After DSBAM is selected, press the key of basic waveform setting to quickly set corresponding carrier waveform.

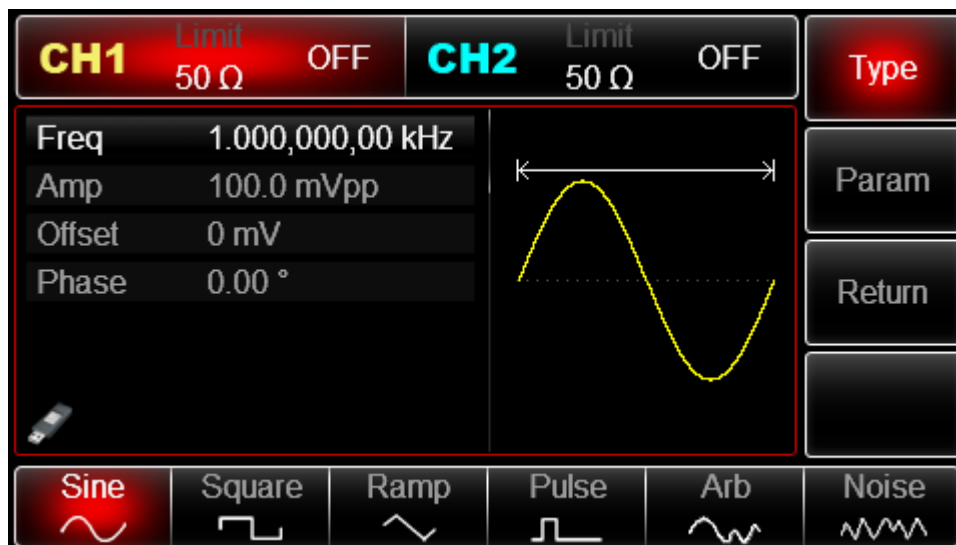

Set carrier frequency

See Carrier wave frequency setting Select modulation source

UTG2000B function/arbitrary waveform generator can select internal or external modulation source. After you use DSBAM function, you can see that modulation source is internal by default. You can change it with multi-functional knob on the interface for using DSBAM function or by pressing **Param** → **Source**

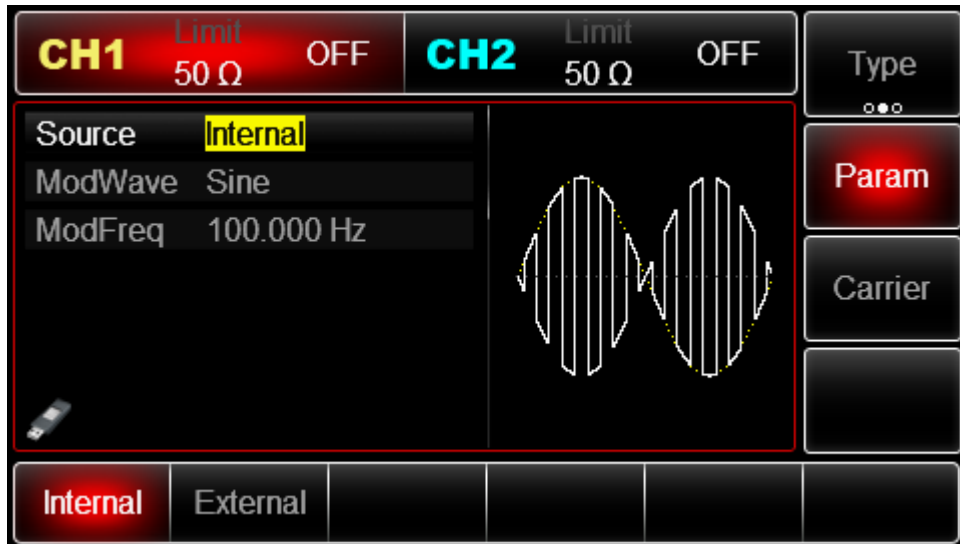

Figure 3 - 10 Select modulation source

Internal source

In case of internal modulation source, modulation wave can be sine wave, square wave, rising ramp wave, falling ramp wave, arbitrary wave and noise, and is sine wave by default. After you use DSBAM function, you can see that modulation wave is sine wave by default. You can change it with multi-functional knob on interface for using amplitude modulation function or by pressing **Param**

→ **ModWave**

- Square wave: duty ratio is 50%
- Rising ramp wave: symmetry degree is 100%
- Falling ramp wave: symmetry degree is 0%
- Arbitrary wave: when selecting arbitrary wave as modulation waveform, function/arbitrary waveform generator limits length of arbitrary wave to 4Mpts by automatic test count.
- Noise: white Gaussian noise

External source

In case of external modulation source, modulation wave and frequency will be hidden in parameter list, when an external waveform will be used to modulate carrier waveform.

DSBAM depth is controlled by ±5V signal level on external analog modulation input terminal (Modulation In connector) of back panel. For example, if modulation depth in parameter list is set to be 100%, SUM output amplitude is the maximum when external modulation signal is +5V and the minimum when external modulation signal is -5V.

Set frequency of modulation wave

When modulation source is internal, frequency of modulation wave can be modulated. After enabling DSBAM function, default of modulation wave frequency is 100Hz. Press **Param** → **ModFreq** to change. Modulation frequency range: 2mHz~1MHz. When modulation source is external, parameter list will hide the modulation wave option and modulation frequency option, and carrier waveform will be modulated by an external waveform. The range of modulation signal input from external is 0Hz~ 20Hz.

Comprehensive example

First make the instrument run in DSBAM mode, and then set an internal sine wave of 1kHz as modulation signal and a square wave with frequency of 2kHz, amplitude of 2Vpp. The specific steps are as follows:

- 1) Use DSBAM function

Press **Mod** → **Type** → **DSBAM** (press soft key **Type** to select if **Type** is not highlighted).

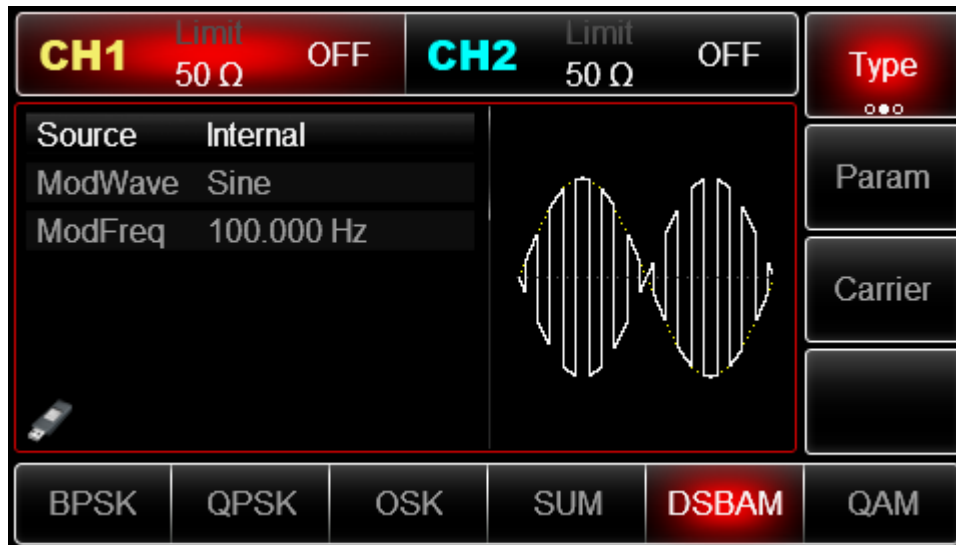

2) Set carrier waveform parameters

Press **Param** → **Type** → **Sine** (if **TYPE** is not highlighted, press **TYPE**)

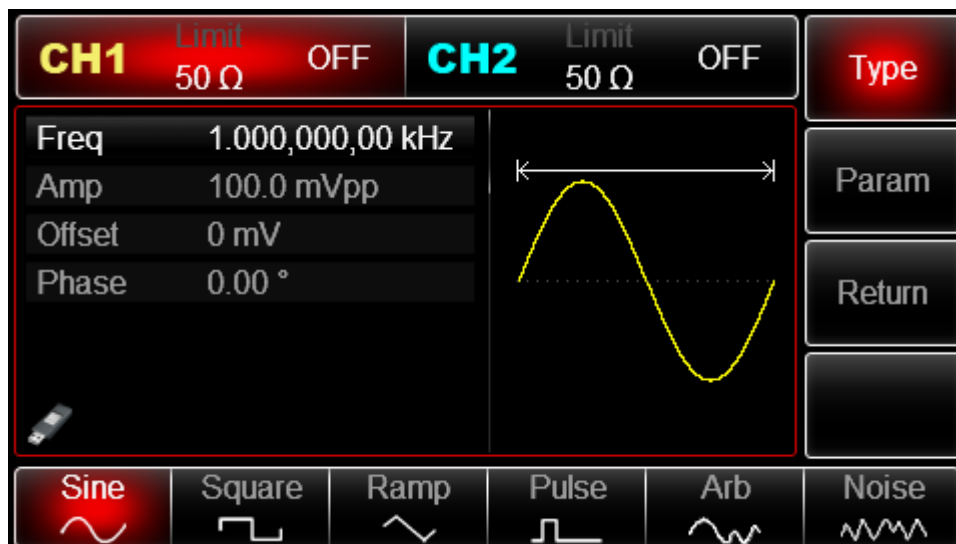

You can use the multifunctional knob and soft keys to set the parameters. After you press **Param**, the following interface will be displayed:

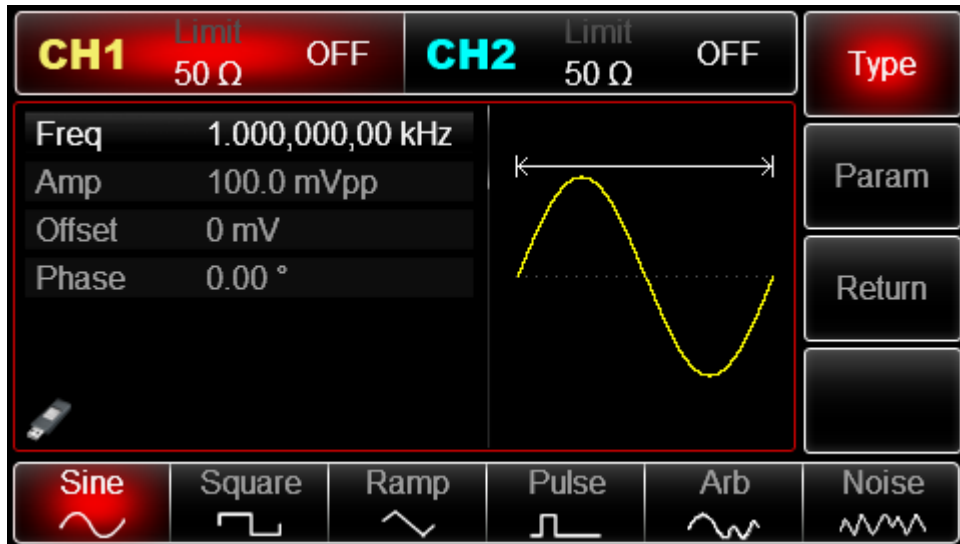

Input the number and select the unit.

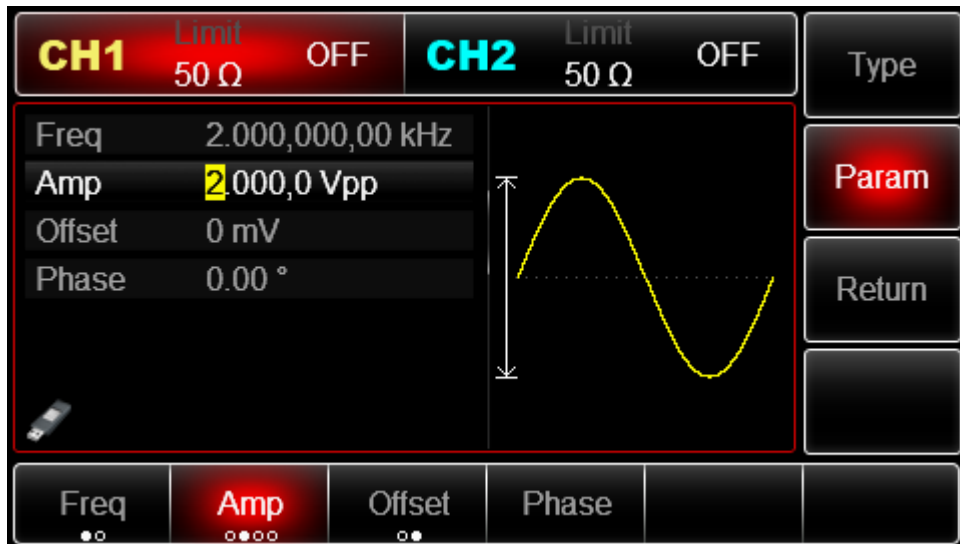

3) Set DSBAM rate and modulation phase

After setting up, press Return to turn to the interface below:

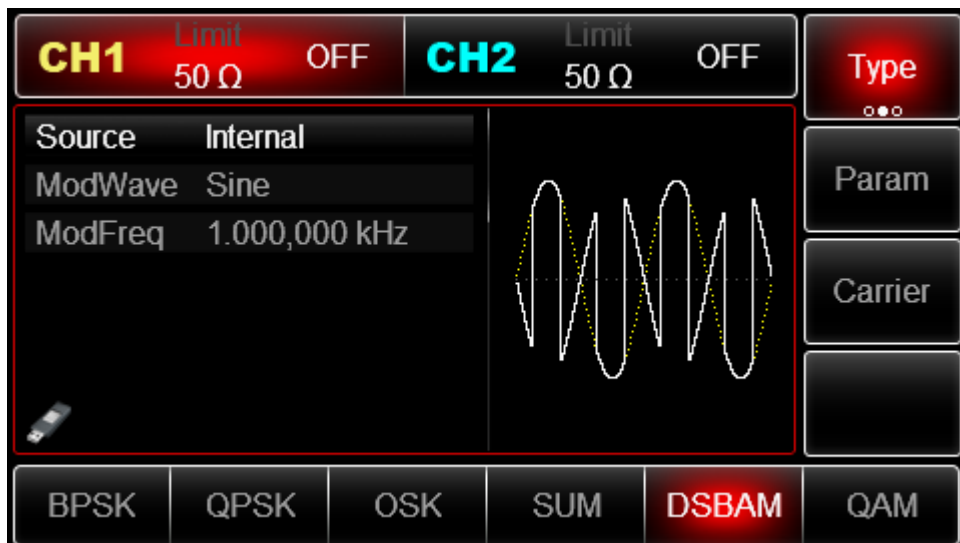

- 4) Use channel output
- 5) Press **CH1** button start channel 1 output quickly. Or enable output by pressing **Utility** and then **CH1 Setting** . After channel output is opened, backlight of **CH1** button is on, and on the right side of channel information label, the font “OFF” changes to “DSBAM”, meaning open channel output.

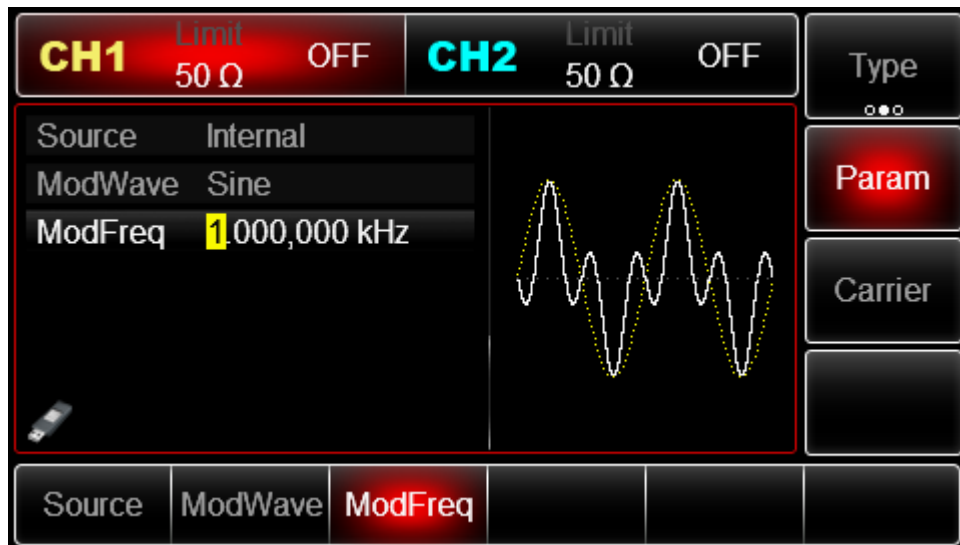
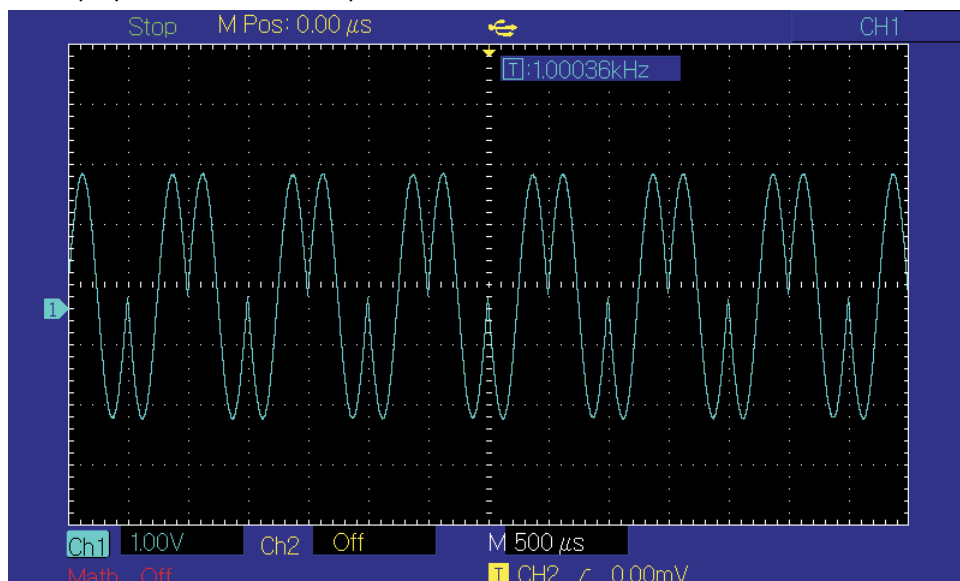

Figure 3 - 11 Use channel output

Waveform displayed on the oscilloscope



### 3.1.12 Quadrature Amplitude Modulation(QAM)

In QAM, two signals of the same frequency but with phase difference of  $90^\circ$  (normally indicated by Sin or Cos) are used as carrier wave, which is subject to amplitude modulation with baseband signal. UTG2000B function/arbitrary waveform generator can output seven modulation modes: 4QAM, 8QAM, 16QAM, 32QAM, 64QAM, 128QAM and 256QAM. The modulation mode of the two channels is mutually independent. You can configure same or different modulation mode for channel 1 and 2.

Note: to prevent phase deviation, it is suggested to use 10MHz as reference output signal and

reference clock input for demodulation devices.

Select QAM

Press **Menu** → **Mod** → **Type** → **QAM** successively to use QAM function (if **Type** is not highlighted, press soft key **Type** to select). After QAM function is used, UTG2000B function/arbitrary waveform generator will output modulated waveform with the current carrier phase and modulation phase.

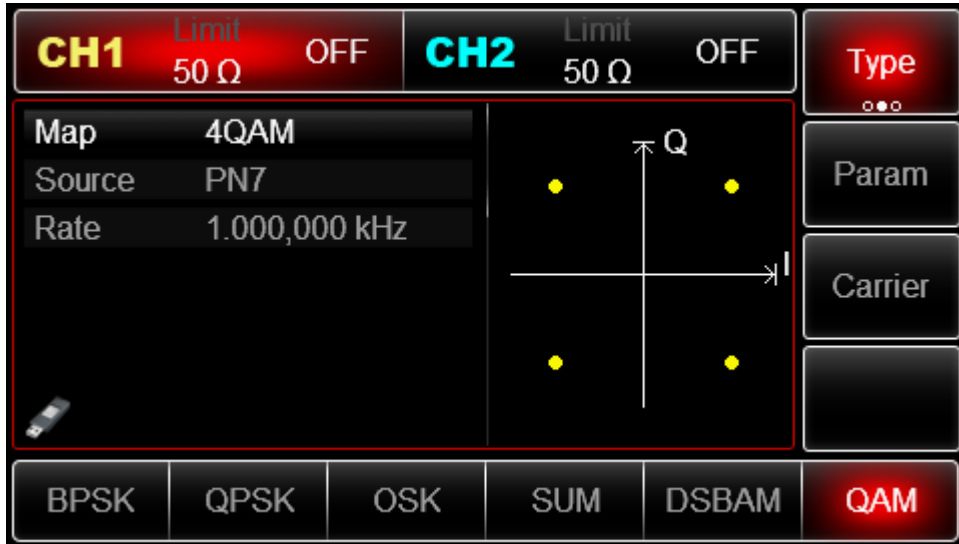

Figure 3 -14 Select QAM function

Set carrier signal parameters

QAM carrier waveform is sine wave.

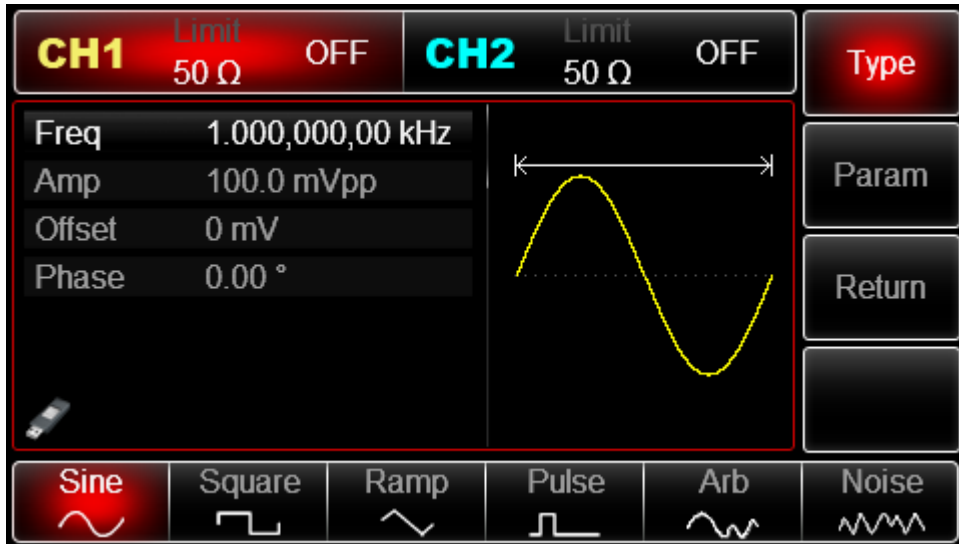

Figure 3 - 13 Select carrier waveform

Set carrier frequency

See Carrier wave frequency setting Set modulation mode

Modulation mode is subsection of constellation, which varies with the modulation mode selected.

Press soft key IQ map to highlight it, and input the required period value through numeric keyboard or direction key and knob, which can be 4QAM, 8QAM, 16QAM, 32QAM, 64QAM, 128QAM or 256QAM.

Select modulation frequency

After enabling the QAM, the default source is PN7. Press **Param** → **Source** and input the source

number, you can set as PN7,PN9,PN11,PN15,PN17,21,PN23,PN25 Set QAM rate

After you use QAM function, you can set QAM rate, which is in the range of 2mHz~1MHz and 100Hz by default. You can change it with multi-functional knob and direction key on the interface for using ASK function or by pressing Param → Rate

Comprehensive example

First make the instrument run in QAM mode, and then set an internal sine wave of 2kHz and 2Vpp as carrier signal. Set rate to be 100Hz and modulation mode to be 64QAM, default source is PN7.

The specific steps are as follows:

#### 1) QAM function

Press **Mod** → **Type** → **QAM** successively (press soft key **Type** to select if **Type** is not highlighted) to use QAM function.

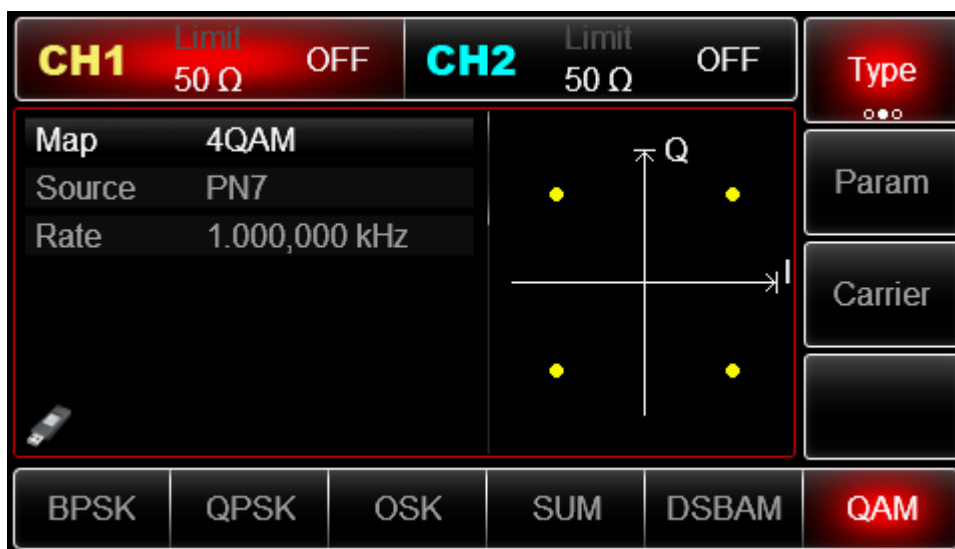
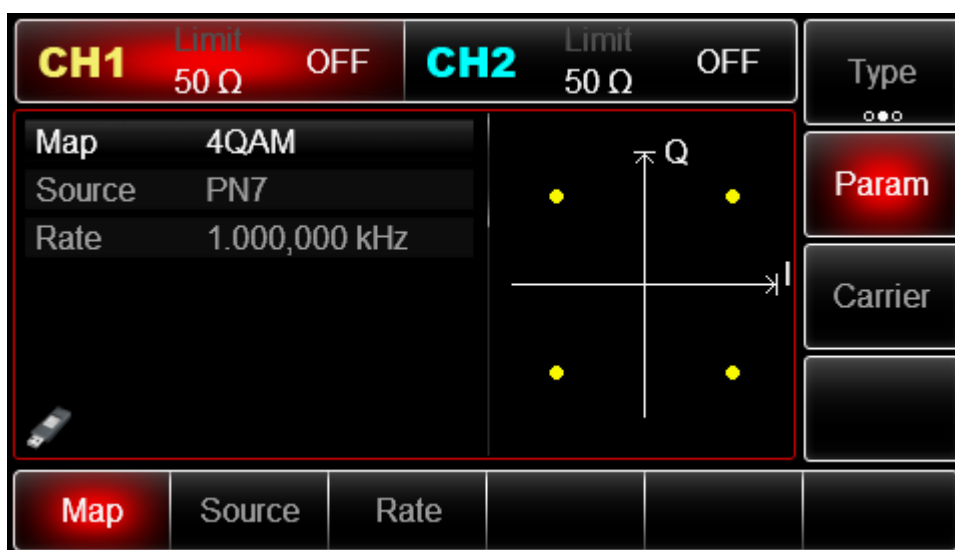

Figure 3 -14 Select QAM function

#### 2) Set carrier signal parameters

Press the key of basic waveform type setting Sine to select carrier signal as sine wave. The default carrier signal is sine wave, so it is unnecessary to change in this example. You can set by pressing **Carrier** → **Type** → **Sine**. You can also press corresponding soft keys of function again, when the interface below will pop up.



To set some parameter, press corresponding soft key, input the required value and select the unit.

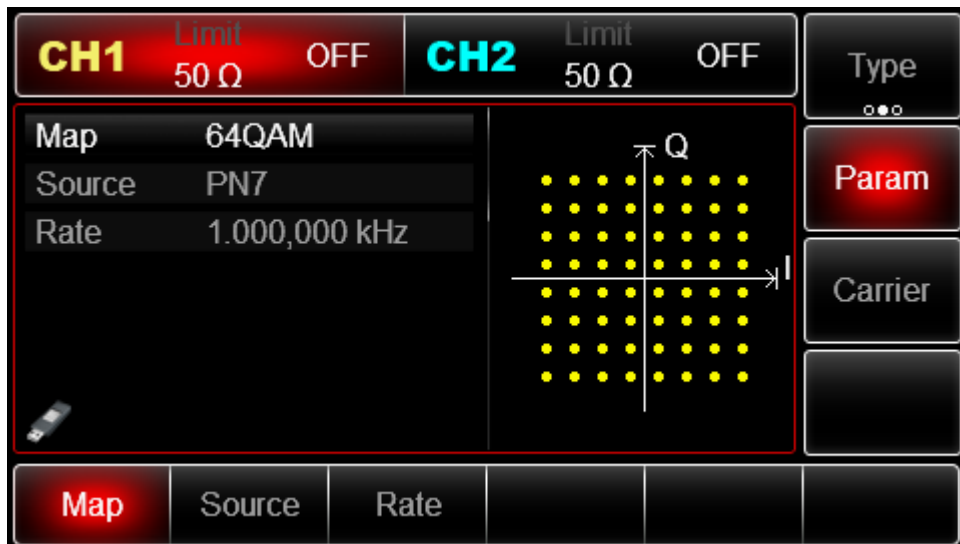

Enable channel output

Press **CH1** button start channel 1 output quickly. Or enable output by pressing **Utility** and then **CH1 Setting**. After channel output is opened, backlight of **CH1** button is on, and on the right side of channel information label, the font “OFF” changes to “QAM”, meaning open channel output.

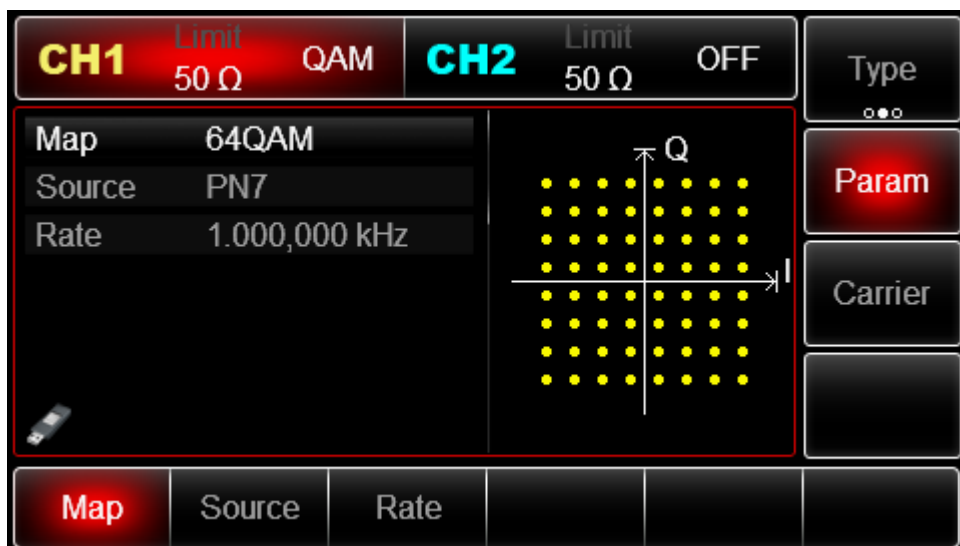

Check the shape of QAM modulation waveform through oscilloscope, which is shown in the figure below:

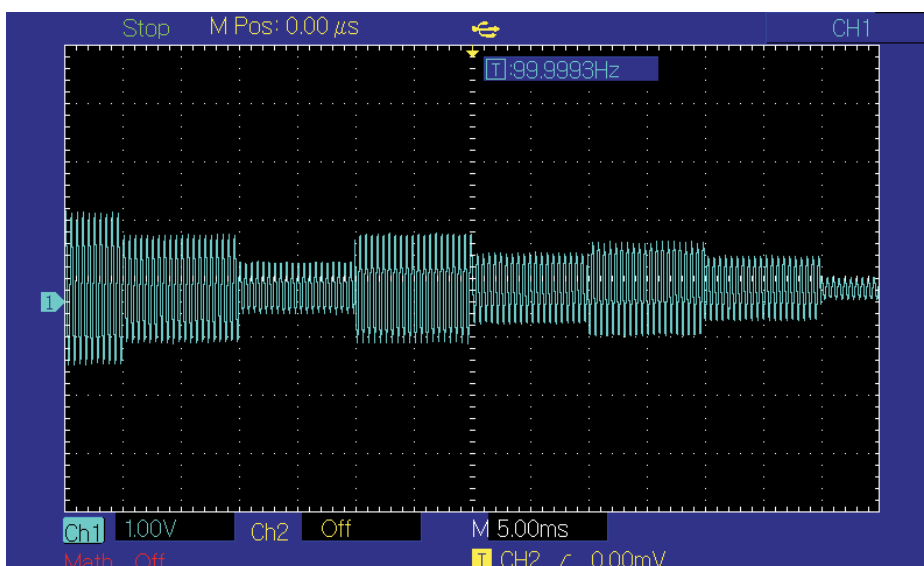

Figure 3 -19 Observe QAM waveform with oscilloscope

### 3.1.13 Pulse Width Modulation (PWM)

In PWM, modulated waveform generally is composed of carrier wave and modulation wave. The pulse width of carrier wave will vary with the amplitude of modulation wave. The modulation mode of the two channels is mutually independent. You can configure same or different modulation mode for channel 1 and 2.

Select PWM

Press **Menu** → **Mod** → **Type** → **PWM** successively to use PWM function (if **Type** is not highlighted, it may be necessary to press soft key **Type** twice to display the next screen of sub-tags). After PWM function is used, UTG2000B function/arbitrary waveform generator will output modulated waveform with the current modulation waveform and carrier wave.

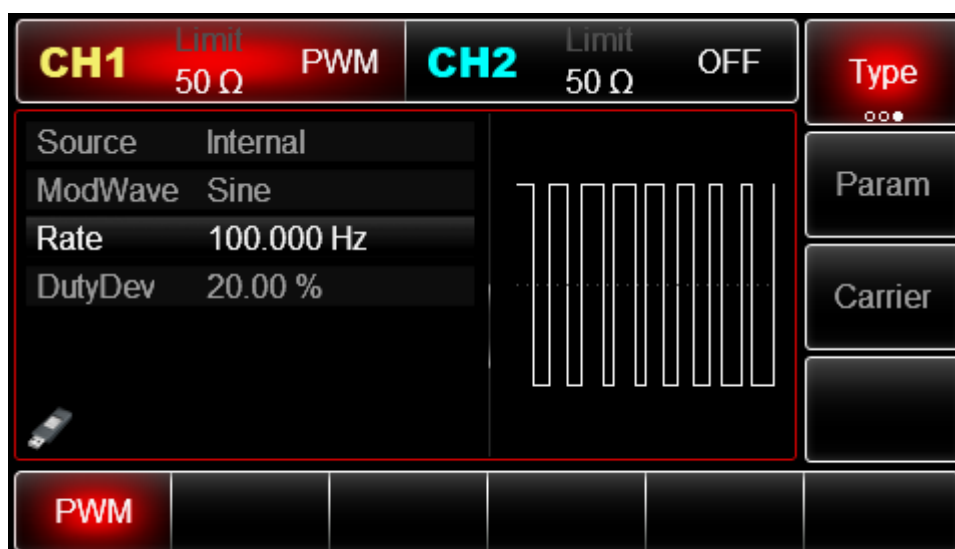

Figure 3 - 20 Select PWM function

Carrier waveform

PWM carrier waveform can only be pulse wave. After PWM is selected, press Carrier to enter interface of carrier waveform. You can see the Pulse Wave is automatically selected.

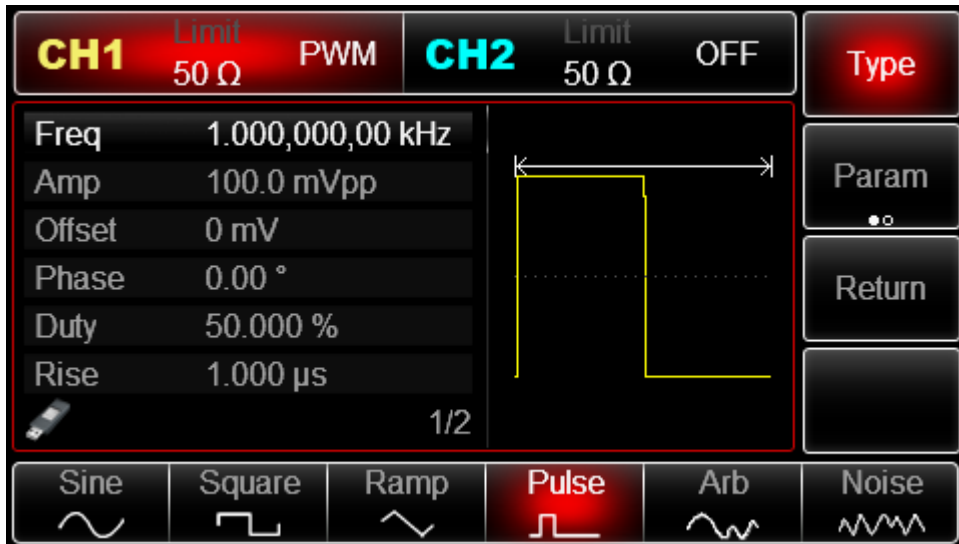

Figure 3 - 21 Set carrier waveform Set carrier frequency

See Carrier Frequency Wave Setting

The frequency range of pulse wave is 1 μH~30MHz. Default frequency is 1kHz. To set carrier frequency, please use multi-functional knob and direction key in the interface or press soft function key **Param** → **Freq** and input the required value and select the unit.

Set carrier duty ratio

The range of duty ratio of pulse wave is 0.01%~99.99%. Default duty ratio is 50%. To set carrier duty ratio, please use multi-functional knob and direction key in the interface or press soft function key **Param** → **Duty**, input the required value and select the unit.

Select modulation source

UTG2000B function/arbitrary waveform generator can select internal or external modulation source. After you use PWM function, you can see that modulation source is internal by default. You can change it with multi-functional knob on the interface for using frequency modulation function or by pressing **Param** → **Source** → **External**

Note: the modulation source can only be selected after PWM function is used.

Press **Menu** → **Mod** → **Type** → **PMW** (if **Type** is not highlighted, it may be necessary to press soft key **Type** twice to display the next screen of sub-tags) to use PWM function.

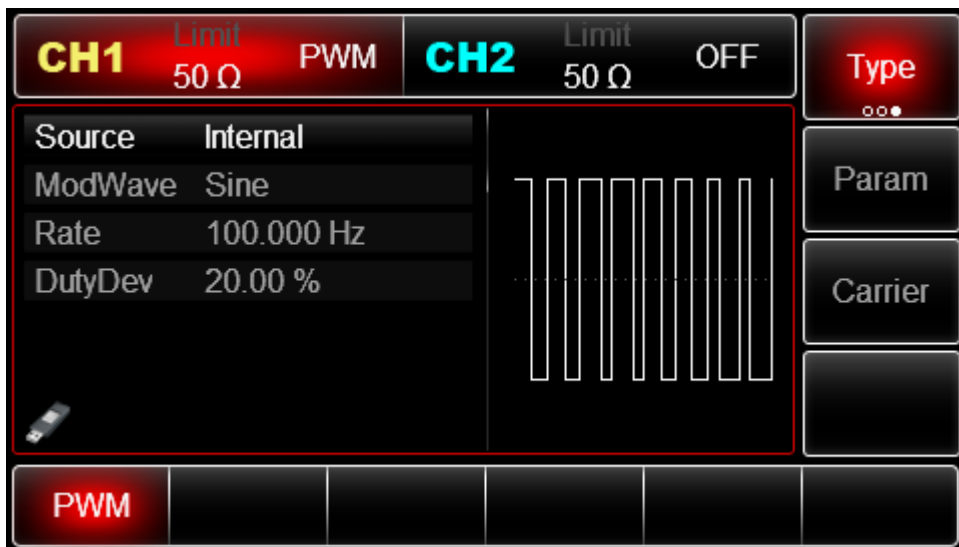

1) Internal source

In case of internal modulation source, modulation wave can be sine wave, square wave, rising ramp wave, falling ramp wave, arbitrary wave and noise, and is sine wave by default. After you use PWM function, you can see that modulation wave is sine wave by default. You can change it with multi-functional knob on interface for using PWM function or by pressing

**Param** → **ModWave**

- Square wave: duty ratio is 50%
- Rising ramp wave: degree of symmetry is 100%
- Falling ramp wave: degree of symmetry is 0%
- Arbitrary wave: when selecting arbitrary wave as modulation waveform, function/arbitrary waveform generator limits length of arbitrary wave to 4kpts by automatic test count.
- Noise: white Gaussian noise

## 2) External source

In case of external modulation source, modulation wave and frequency will be hidden in parameter list, when an external waveform will be used to modulate carrier waveform.

Duty ratio deviation of PWM is controlled by  $\pm 5V$  signal level on external analog modulation input terminal (Modulation In connector) of back panel. For example, if duty ratio deviation in parameter list is set to be 15%, duty ratio of carrier signal (pulse wave) increases by 15% when external modulation signal is +5V. Lower external signal level generates less deviation.

### Set modulation frequency

When modulation source is internal, frequency of modulation wave can be modulated. After enabling PWM function, default of modulation wave frequency is 100Hz.

Press **Param** → **ModFreq** to change. Modulation frequency range: 2mHz~1MHz. When modulation source is external, parameter list will hide the modulation wave option and modulation frequency option, and carrier waveform will be modulated by an external waveform (impulse wave). The range of modulation signal input from external is 0Hz~20Hz.

### Set duty ratio deviation

Duty ratio deviation is deviation of modulated waveform from the current carrier duty ratio. The range of PWM duty ratio is 0%~49.99%, 20% by default. You can change it with multi-functional knob and direction key on interface for using PWM function or by pressing **Param** → **DutyDev**

- Duty ratio deviation is change in duty ratio of modulated waveform relative to original pulse waveform (%).
- Duty ratio deviation should not be more than current duty ratio of pulse wave.
- The sum of duty ratio deviation and current duty ratio of pulse wave must be  $\leq 99.99\%$ .
- Duty ratio deviation is restricted by minimum duty ratio of pulse wave and the current edge time.

### Comprehensive example

First make the instrument run in PWM mode, and then set an internal sine wave of 1kHz as modulation signal and a pulse wave with frequency of 10kHz, amplitude of 2Vpp, duty ratio of 50% and rising/falling time of 100ns as carrier signal. Finally set duty ratio deviation to be 40%. The specific steps are as follows:

#### 1) Use PWM function

Press **Menu** → **Mod** → **Type** → **PMW** successively (if **Type** is not highlighted, it may be necessary to press soft key **Type** twice to display the next screen of sub-tags) to use PWM function.

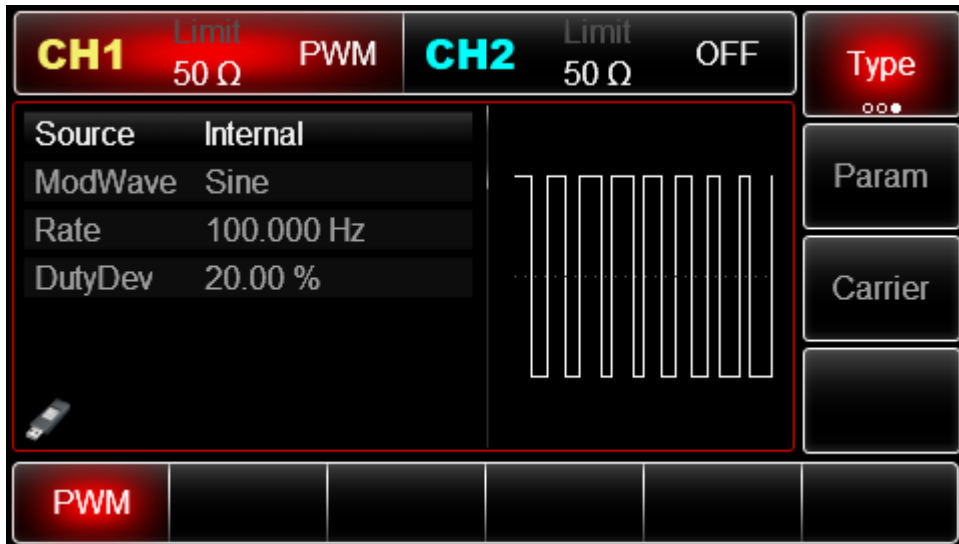

Figure 3 -23 Select PWM function

2) Set modulation signal parameters

Set with multi-functional knob and direction key after using PWM function. You can also press corresponding soft keys of function on the above interface for using PWM function, when the interface below will pop up. To set some parameter, press corresponding soft key, input the required value and select the unit.

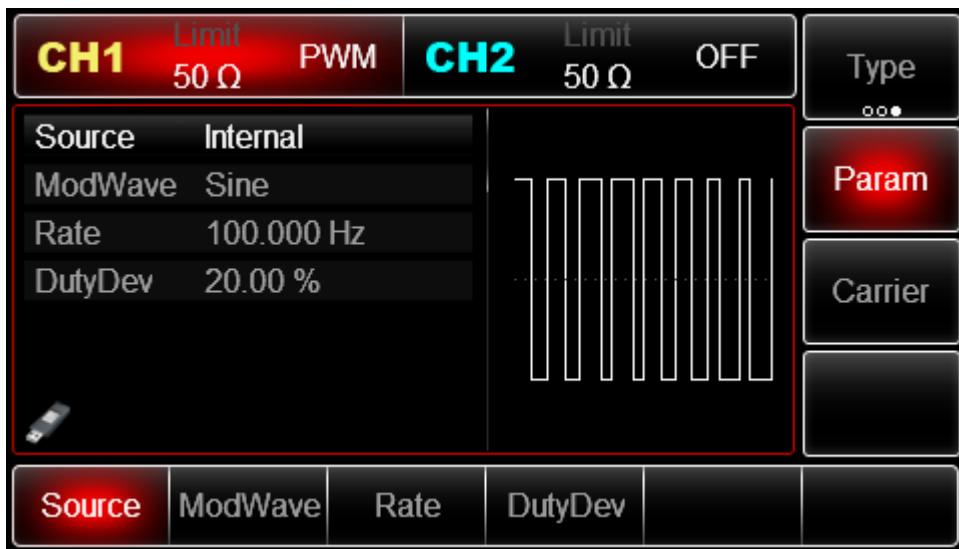

Figure 3 -24 Set modulation parameters

3) Set carrier signal parameters

Press soft function key Carrier to enter the interface for setting carrier parameters in the interface for using PWM function.

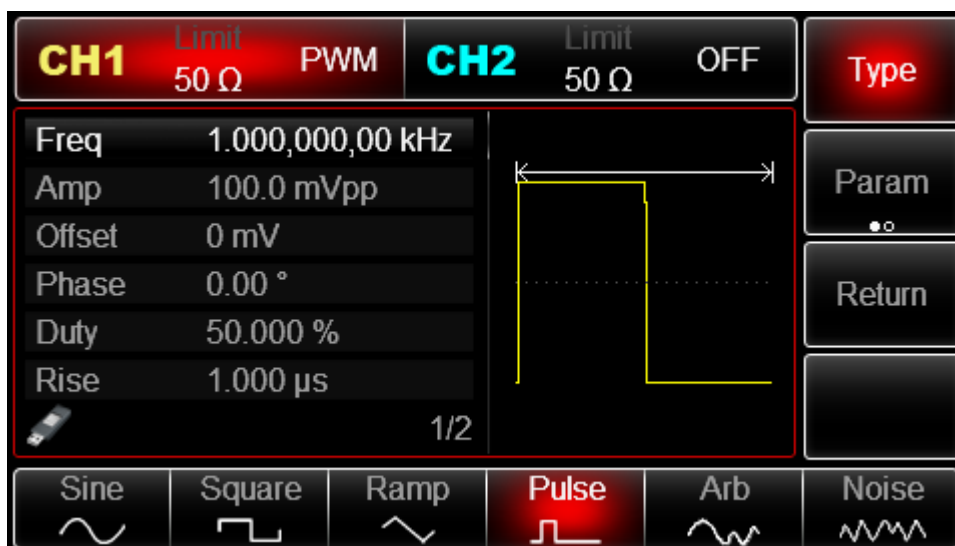

Figure 3 -25 Set carrier parameters

You can set with multi-functional knob and direction key. You can also press corresponding soft keys of function again, when the interface below will pop up. To set some parameter, press corresponding soft key, input the required value and select the unit.

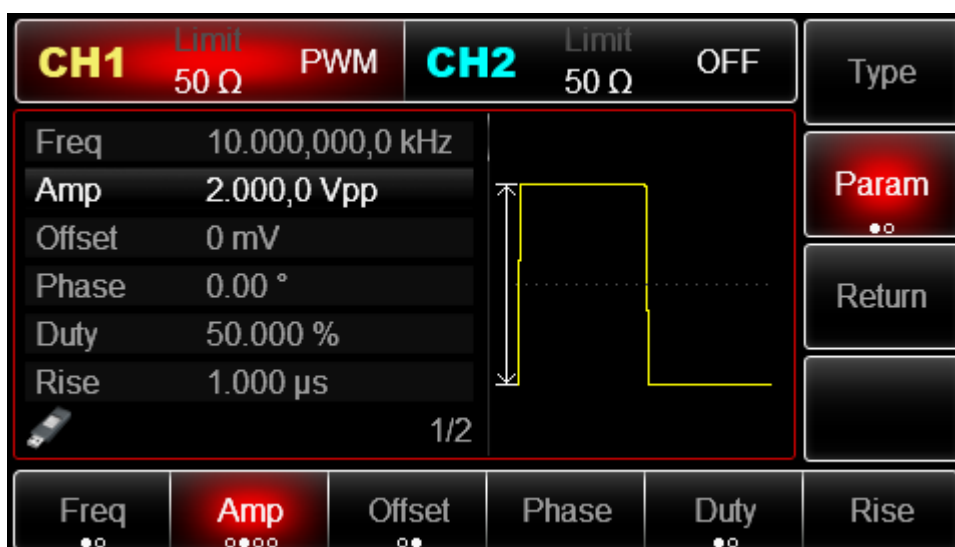

Figure 3 - 26 Set rising edge

#### 4) Set duty ratio deviation

Press **Return** to return to the interface below to set frequency deviation after setting carrier parameters.

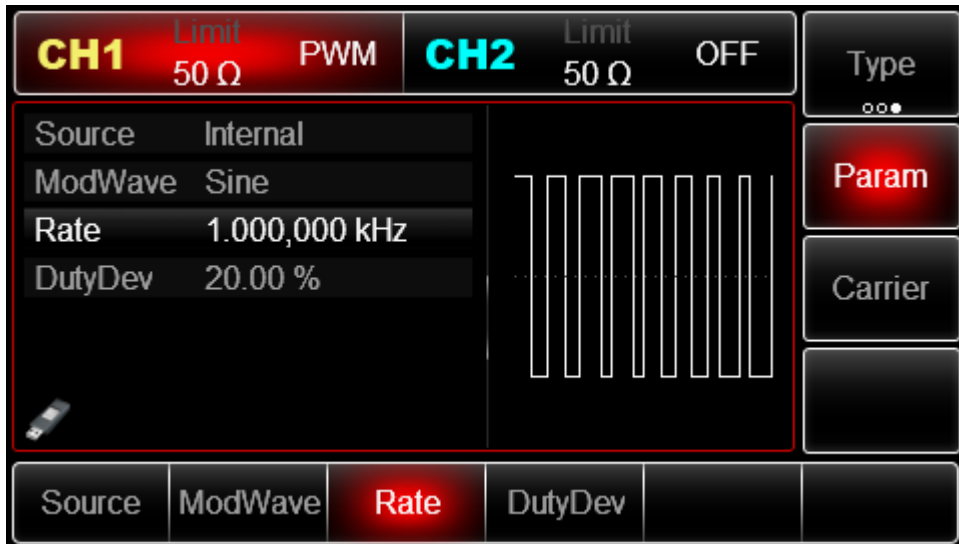

Figure 3 - 27 Set modulation parameters

You can set with multi-functional knob and direction key. You can also press soft function key **Param** → **DutyDev** again, input the number 40 through numeric keyboard and press soft key % to set duty ratio deviation.

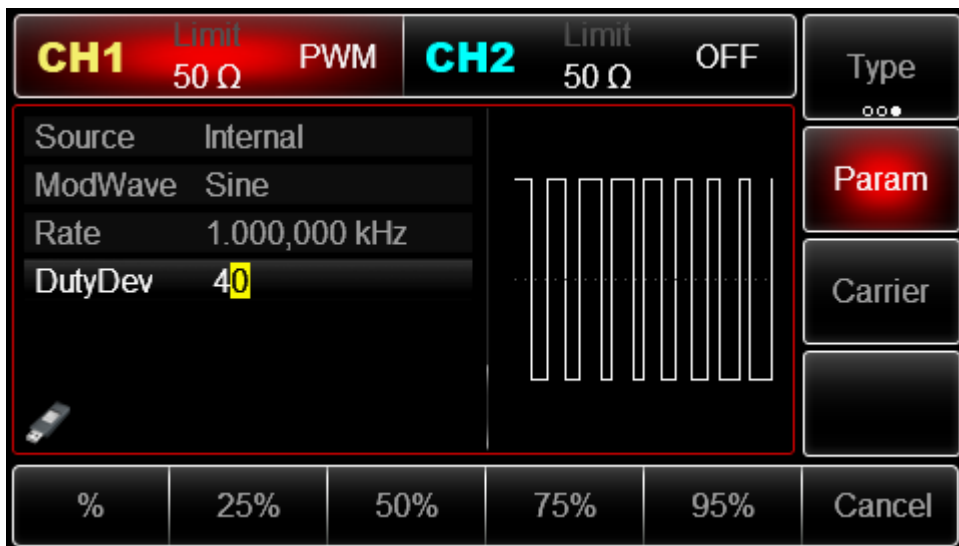
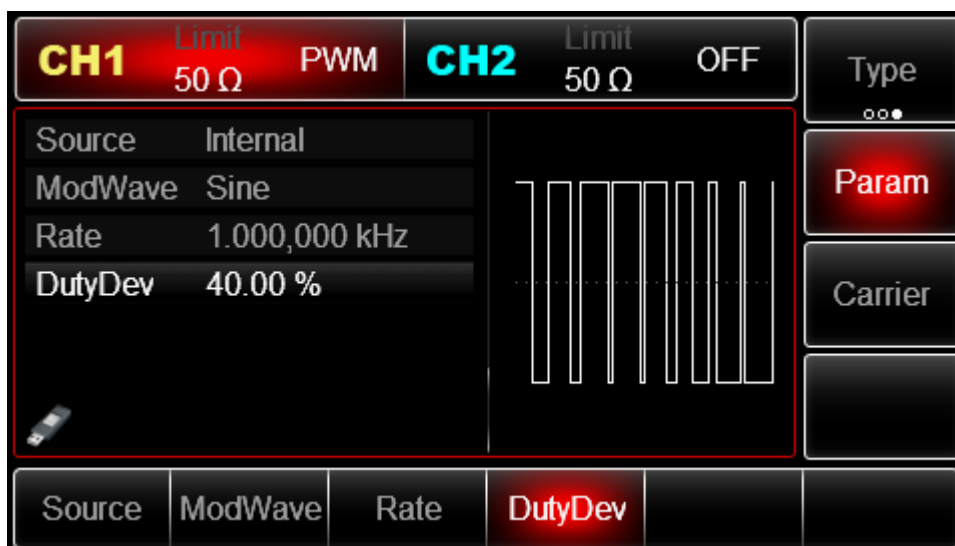

Figure 3 -28 Set duty ratio deviation

5) Enable channel output

Press **CH1** button start channel 1 output quickly. Or enable output by pressing **Utility** and then **CH1 Setting**. After channel output is opened, backlight of **CH1** button is on, and on the right side of channel information label, the font “OFF” changes to “PWM”, meaning open channel output.



Check the shape of PWM modulation waveform through oscilloscope, which is shown in the figure below:

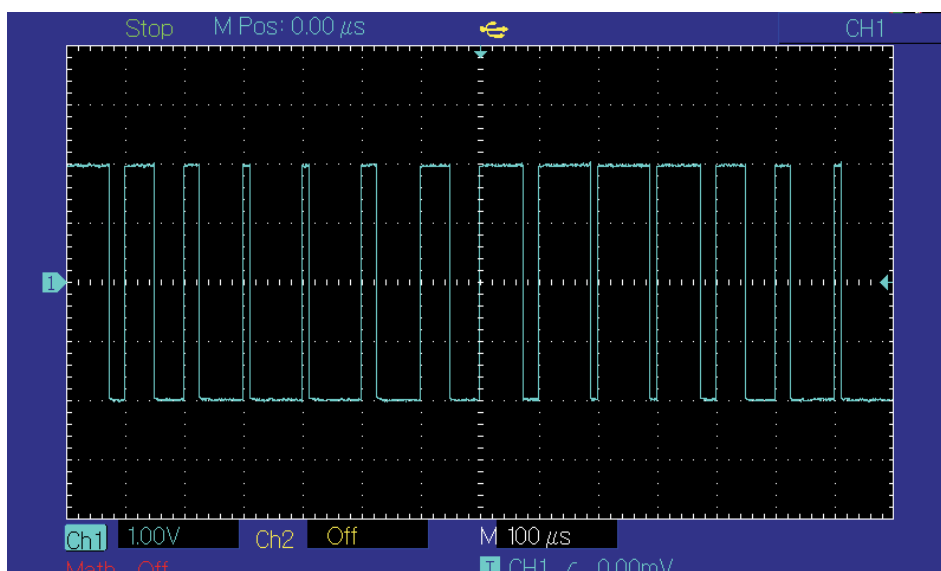

Figure 3 - 30 Observe PWM waveform with oscilloscope

## 3.2 Output Frequency Sweep Waveform

When selecting frequency sweep mode, the output frequency of function/arbitrary waveform generator changes in a linear or logarithmic way from starting frequency to stop frequency in designated frequency sweep time. Trigger source can be internal, external or manual; it can generate frequency sweep output for sine wave, square wave, ramp wave and arbitrary wave (except DC). The modulation mode of the two channels is mutually independent. You can configure same or different modulation mode for channel 1 and 2.

### 3.2.1 Select Frequency Sweep Start frequency sweep

Press **Menu** → **Sweep** to start frequency sweep. After frequency sweep is used, UTG2000B function/arbitrary waveform generator will output frequency sweep waveform with the current

setting.

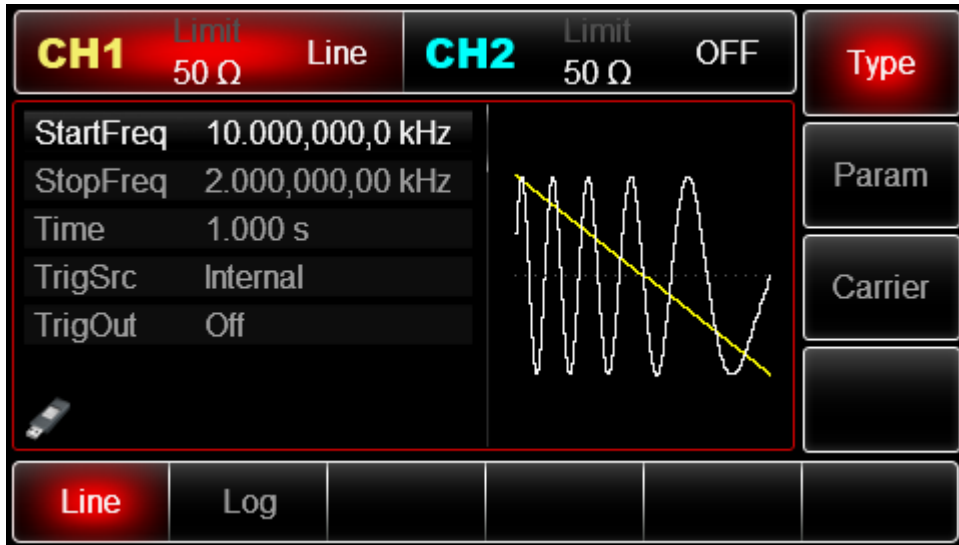

Figure 3 -31 Select SWEEP function

Select frequency sweep waveform

After frequency sweep is started, press Carrier to select frequency sweep waveform. The interface that pops up is shown in the figure below:

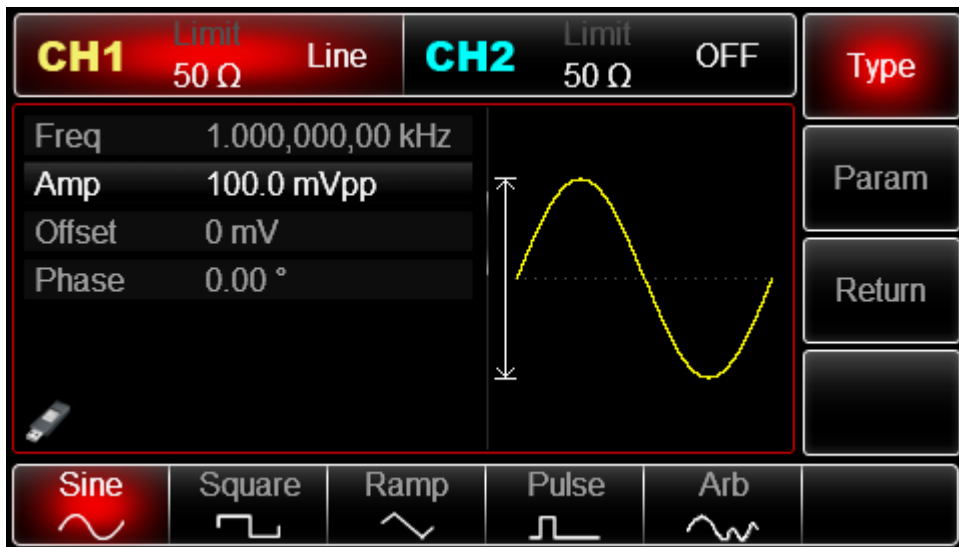

Figure 3 - 32 Select frequency sweep waveform

### 3.2.2 Set Starting and Stop Frequency

Starting frequency and stop frequency are upper limit and lower limit of frequency sweep. Function/ arbitrary waveform generator always sweeps from starting frequency to stop frequency and then returns to starting frequency. To set starting or stop frequency, please press **Param** → **StartFreq** or **StopFreq** , input number through numeric keyboard and press corresponding soft key of unit to finish setting.

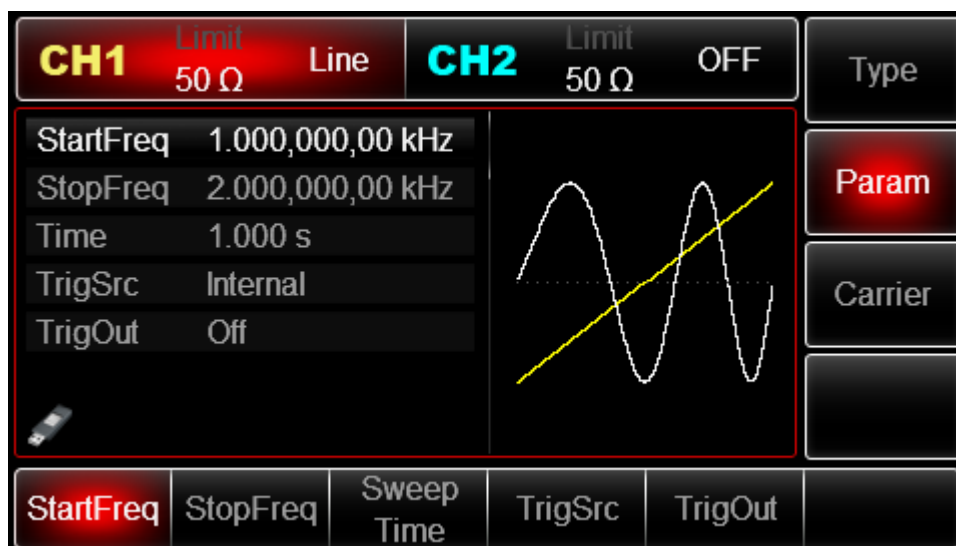

Figure 3 - 33 Set frequency sweep parameters

- When starting frequency < stop frequency, function / arbitrary waveform generator sweeps from low frequency to high frequency.
- When starting frequency > stop frequency, function / arbitrary waveform generator sweeps from high frequency to low frequency.
- When starting frequency = stop frequency, function / arbitrary waveform generator outputs fixed frequency.
- The synchronous signal of frequency sweep mode is low from starting point to midpoint of frequency sweep time, and high from midpoint to end of frequency sweep time.

By default, starting frequency is 1kHz and stop frequency is 2kHz, but the range of starting and stop frequency can vary with frequency sweep waveform. See the table below for the frequency range of frequency sweep wave:

Table 3 - 4

Carrier waveform	Frequency					
	UTG2122B		UTG2082B		UTG2062B	
	Min	Max	Min	Max	Min	Max
Sine	1μHz	120MHz	1μHz	80MHz	1μHz	60MHz
Square	1μHz	30MHz	1μHz	25MHz	1μHz	25MHz
Ramp	1μHz	5MHz	1μHz	4MHz	1μHz	3MHz
Pulse	1μHz	30MHz	1μHz	25MHz	1μHz	25MHz
Arbitrary	1μHz	25MHz	1μHz	20MHz	1μHz	15MHz

### 3.2.3 Frequency Sweep Mode

For linear frequency sweep, waveform generator changes output frequency in a linear way during frequency sweep; for logarithmic frequency sweep, waveform generator changes output frequency in a logarithmic way. Linear frequency sweep mode is default. To change it, please press soft key **Type** → **Log** on the interface for starting frequency sweep mode (please press **Return** first to enter the interface for selecting frequency sweep waveform).



Figure 3 - 35 Select logarithmic frequency sweep

### 3.2.4 Frequency Sweep Time

Set the time from starting frequency to stop frequency, which is 1s by default and in the range of 1ms~500s. To change it, you can use multi-functional knob and direction key on the interface for selecting frequency sweep mode or press soft function key

[Param] → [SweepTime], input number through numeric keyboard and press corresponding soft key of unit.

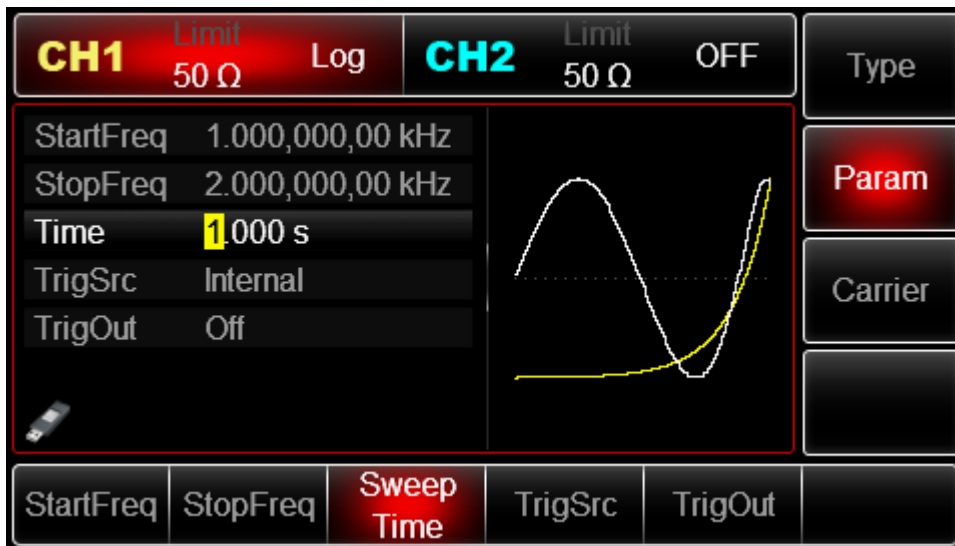
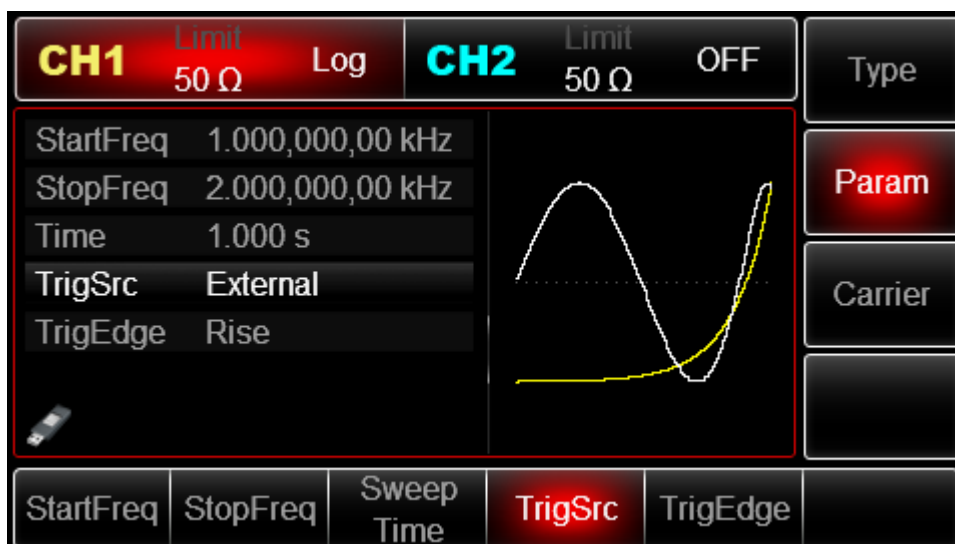

Figure 3 - 36 Set frequency sweep time

### 3.2.5 Select Trigger Source

The signal generator generates frequency sweep output upon receiving a trigger signal and then waits for the next trigger signal. The trigger source of frequency sweep can be internal, external or manual. To change it, you can use multi-functional knob and direction key on the interface for selecting frequency sweep mode or press soft function key [Param] → [TrigSrc]



- 1) In case of internal trigger, waveform generator will output continuous frequency sweep, the rate of which is determined by frequency sweep time.
- 2) In case of external trigger, waveform generator will accept a hardware trigger that has been applied to external digital modulation interface (FSK Trig connector) of back panel. The waveform generator will start frequency sweep upon receiving a TTL pulse with designated polarity. Note: in the event of external trigger source, trigger output will be hidden in parameter list, as trigger output is also achieved through external digital modulation interface (FSK Trig connector). This interface cannot be simultaneously used as external trigger input and internal trigger output.

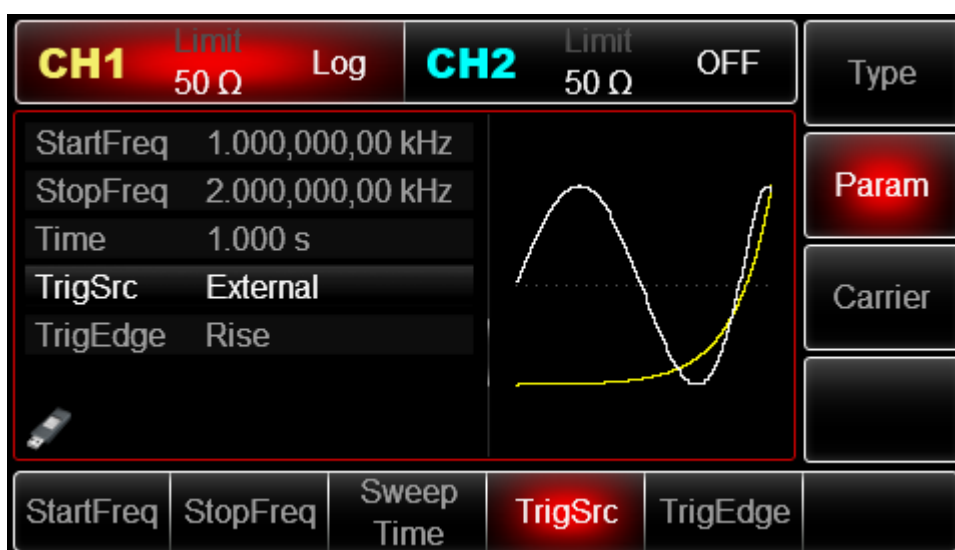

Figure 3 - 38 Select external trigger source

- 3) In case of manual trigger, backlight of **Trigger** on front panel flashes. Frequency sweep is output upon pressing **Trigger**.

### 3.2.6 Trigger Output

In case of internal or manual trigger source, the trigger signal (square wave) can be output through external digital modulation interface (FSK Trig connector), compatible with TTL level. The default trigger output is "OFF". To change it, you can use multi-functional knob and direction key on the

interface for selecting frequency sweep mode or press Page Up/Down and soft function key **Param** → **TrigOut** → **On** successively.

- In internal trigger, signal generator outputs a square wave with duty ratio of 50% from external digital modulation interface (FSK Trig connector) when frequency sweep starts. Trigger period depends on designated frequency sweep time.
- In manual trigger, signal generator outputs a pulse more than 1μs wide from external digital modulation interface (FSK Trig connector) when frequency sweep starts.
- In external trigger, trigger output will be hidden in parameter list, as trigger output is also achieved through external digital modulation interface (FSK Trig connector). This interface cannot be simultaneously used as external trigger input and internal trigger output.

### 3.2.7 Trigger Edge

Edge can be designated when external digital modulation interface (FSK Trig connector) is used as input. When it is used as input (i.e. internal trigger source), “rising edge” means that rising edge of external signal triggers output of a frequency sweep wave, and “falling edge” means that falling edge of external signal triggers output of a frequency sweep wave. The default edge is “rising edge”. To change it, you can use multi-functional knob and direction key on the interface for selecting frequency sweep mode or press soft key

**Param** → **TrigEdge** → **Fall**.

### 3.2.8 Comprehensive Example

First make the instrument run in frequency sweep mode, and then set a square wave signal with amplitude of 1Vpp and duty ratio of 50% as frequency sweep wave. The frequency sweep mode is linear. Set starting frequency to be 1kHz, stop frequency to be 50kHz and frequency sweep time to be 2ms. The specific steps are as follows:

Use frequency sweep function

Press **Menu** → **Sweep** → **Type** → **Line** successively to display linear frequency sweep (press soft key **Type** to select if **Type** is not highlighted) to start linear frequency sweep function.

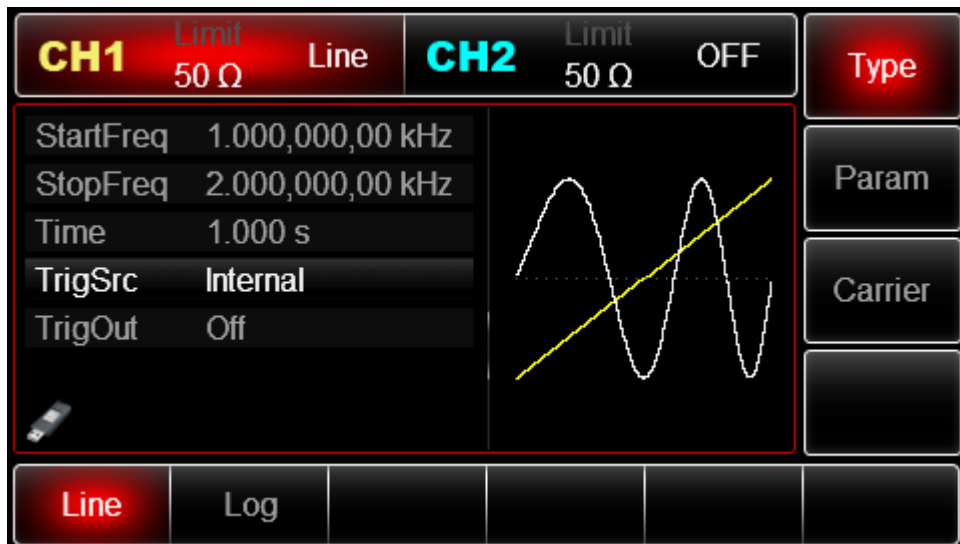

Figure 3 -39 Select SWEEP function

1) Select frequency sweep waveform

After linear frequency sweep function is used, press **Carrier** → **Type** → **Square** to select frequency sweep waveform, when the interface below will pop up:

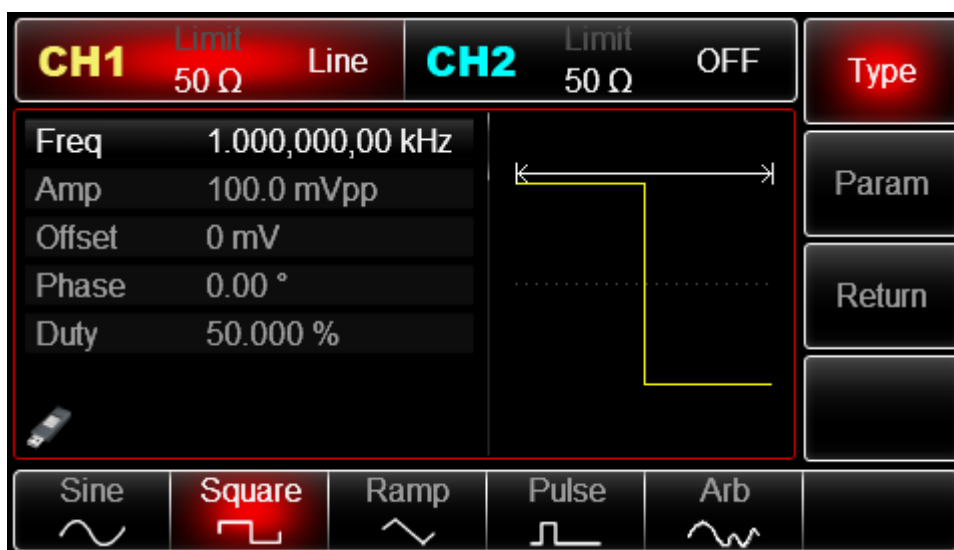

Figure 3 - 40 Select frequency sweep waveform

2) You can set amplitude with multi-functional knob and direction key. You can also press corresponding soft function keys again, when the interface below will pop up. To set some parameter, press corresponding soft key, input the required value and select the unit.

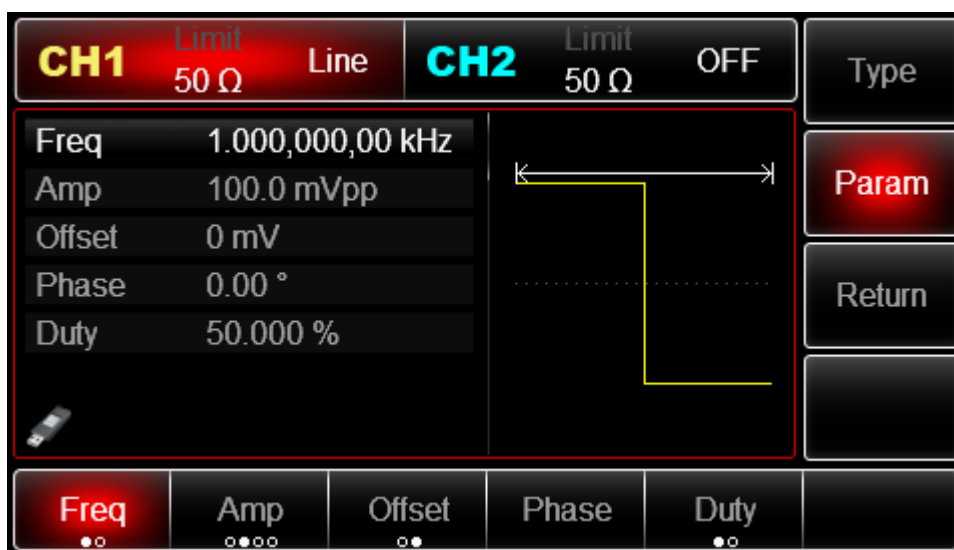

Figure 3 -41 Set waveform amplitude

3) Set starting/stop frequency, frequency sweep time, trigger source and edge

Press **Return** to return to the interface below after selecting frequency sweep waveform and relevant parameters:

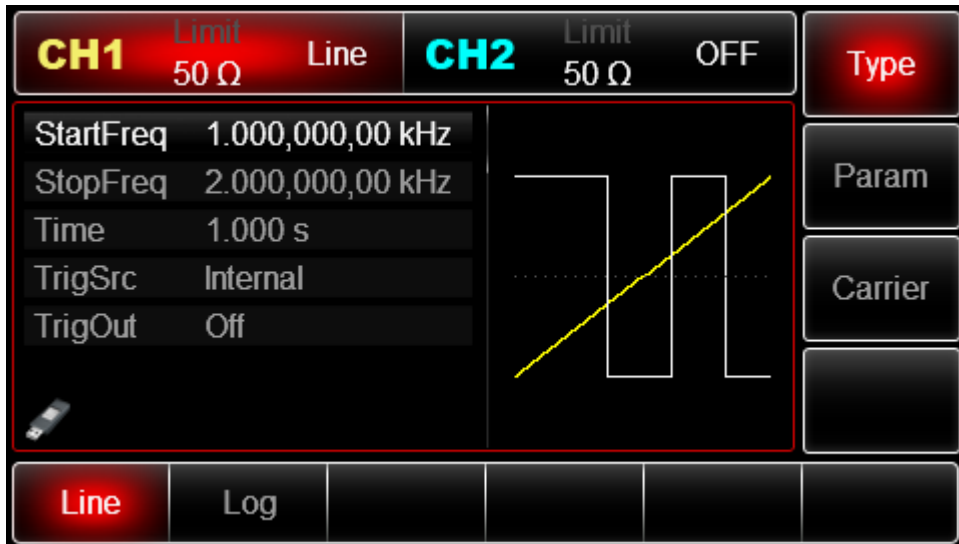

Figure 3 -42 Set frequency sweep parameters

You can set with multi-functional knob and direction key. You can also press corresponding soft function keys again, when the interface below will pop up. To set some parameter, press **Param** , input the required value and select the unit.

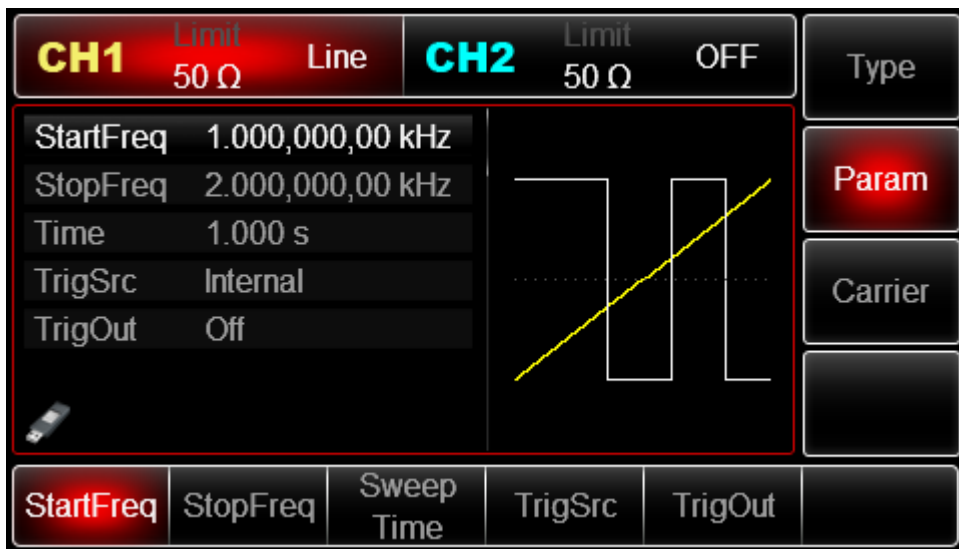
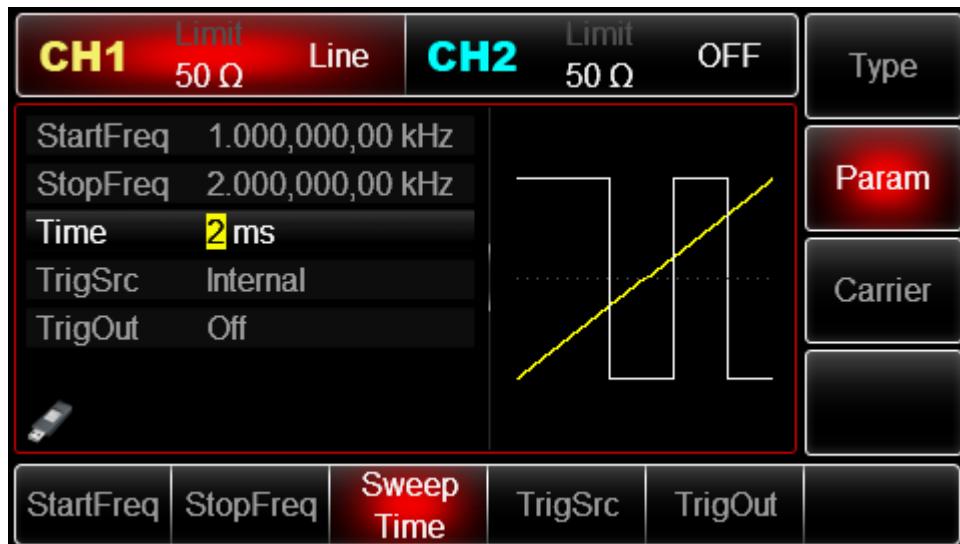

Figure 3 - 43 Set trigger frequency

4) Enable channel output

Press **CH1** button start channel 1 output quickly. Or enable output by pressing **Utility** and then **CH1 Setting** . After channel output is opened, backlight of **CH1** button is on, and on the right side of channel information label, the font “OFF” changes to “Line” , meaning open channel output.



Check the shape of frequency sweep waveform through oscilloscope, which is shown in the figure below:

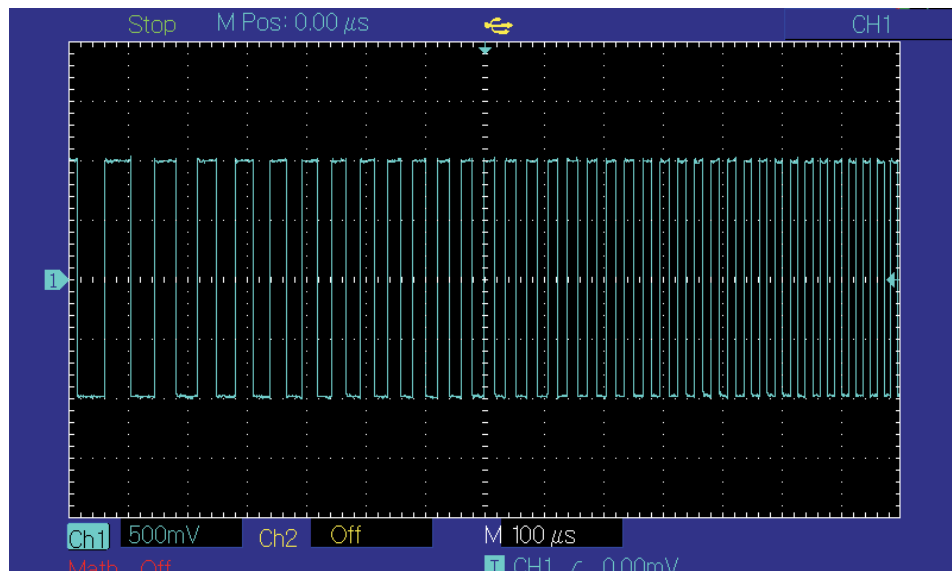

### 3.3 Output Burst

Signal generator can create a waveform with designated recurring number (known as pulse train). UTG2000B supports control of pulse train output with internal, external or manual trigger, and three types of pulse train, including N cycle, gating and infinite. It can generate pulse train for sine wave, square wave, ramp wave, pulse wave, arbitrary wave (except DC) and noise (only applicable to gating pulse train). The modulation mode of the two channels is mutually independent. You can configure same or different modulation mode for channel 1 and 2.

#### 3.3.1 Select Burst

1) Start Burst function

Press **Menu** → **Burst** to start function of pulse. After pulse train function is used, UTG2000B function/arbitrary waveform generator will output pulse train with the current setting.

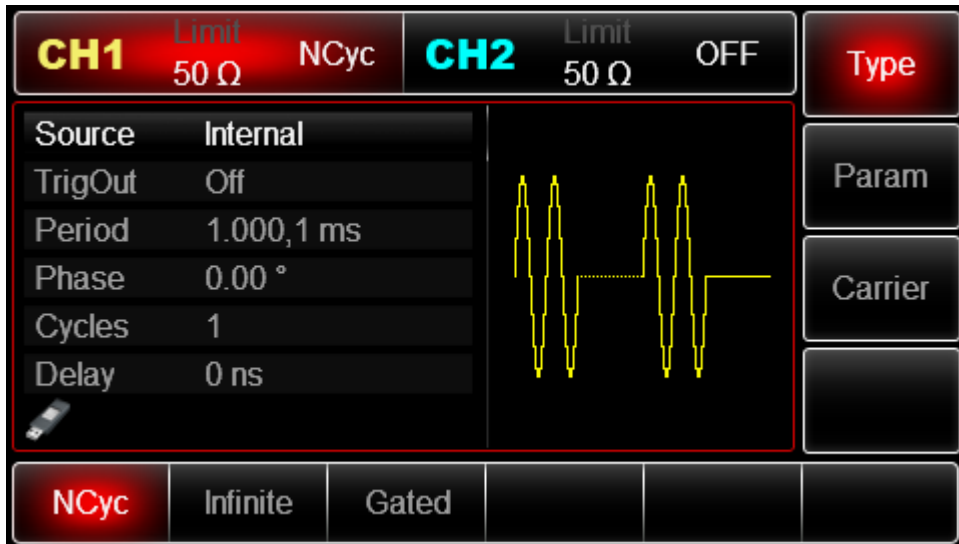

Figure 3 -46 Select BURST function

2) Select waveform

- N cycle mode supports sine wave, square wave, ramp wave, pulse wave and arbitrary wave (except DC).
- Gating mode supports sine wave, square wave, ramp wave, pulse wave, arbitrary wave (except DC) and noise.
- Infinite mode supports sine wave, square wave, ramp wave, pulse wave and arbitrary wave (except DC).

After pulse train function is started, press **Carrier** → **Type** to select frequency sweep waveform. The interface that pops up is shown in the figure below:

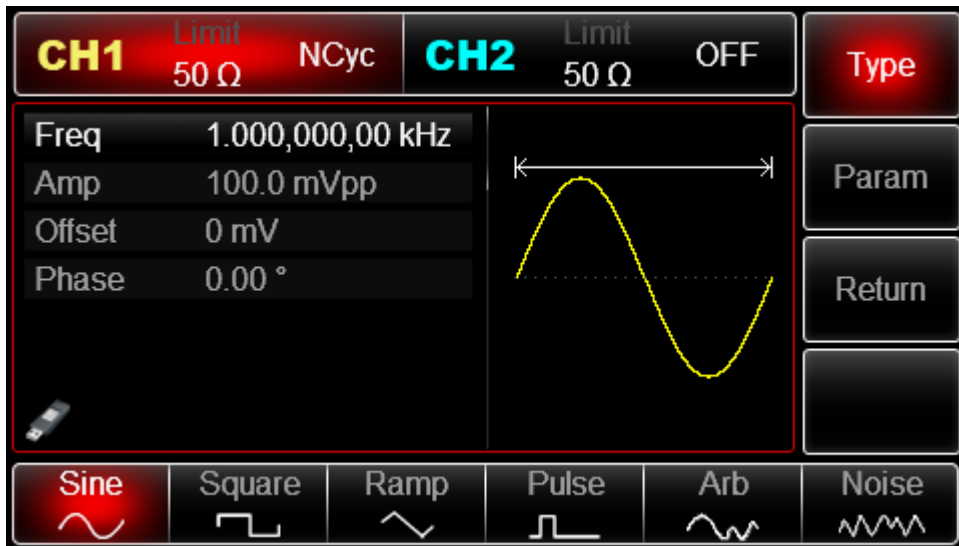

Figure 3 -47 Select waveform

3) Set waveform frequency

In N cycle and gating modes, waveform frequency defines signal frequency during period of pulse train. In N cycle mode, the pulse train will be output with designated cycle index and waveform frequency. In gating mode, when trigger signal is at high level, pulse train is output with waveform frequency.

Note: waveform frequency is different with period of pulse train that designates interval between pulse trains (only for N cycle mode). The default frequency of waveform is 1kHz. See the table

below for the range:

Table 3 -5

Carrier waveform	Frequency					
	UTG2122B		UTG2082B		UTG2062B	
	Min	Max	Min	Max	Min	Max
Sine	1μHz	120MHz	1μHz	80MHz	1μHz	60MHz
Square	1μHz	30MHz	1μHz	25MHz	1μHz	25MHz
Ramp	1μHz	5MHz	1μHz	4MHz	1μHz	3MHz
Pulse	1μHz	30MHz	1μHz	25MHz	1μHz	25MHz
Arbitrary	1μHz	25MHz	1μHz	20MHz	1μHz	15MHz

To set waveform frequency, please use multi-functional knob and direction key or press soft function key Freq , input the required value and select the unit after selecting waveform.

### 3.3.2 Type of Burst

UTG2000B can output three types of pulse train, N cycle, gating and infinite. The default type is N cycle.

N cycle mode

Press soft keys **Type** → **N** Cyc successively on the interface for starting pulse function to enter N cycle mode. In this mode, the waveform generator will output a waveform with designated recurring number (pulse train) upon receiving trigger. After outputting a designated number of cycles, the waveform generator will stop and wait for the next trigger. The trigger source of pulse train can be internal, external or manual in this mode. To change it, you can use multi-functional knob and direction key on the interface for selecting type of pulse train (as shown in the figure below) or press soft function key **Param** → **Source**

Note: if the trigger source is external, trigger output options will be hidden. Because external digital modulation interface(FSK Trig connector) cannot be used as external trigger input and internal trigger output at the same time.

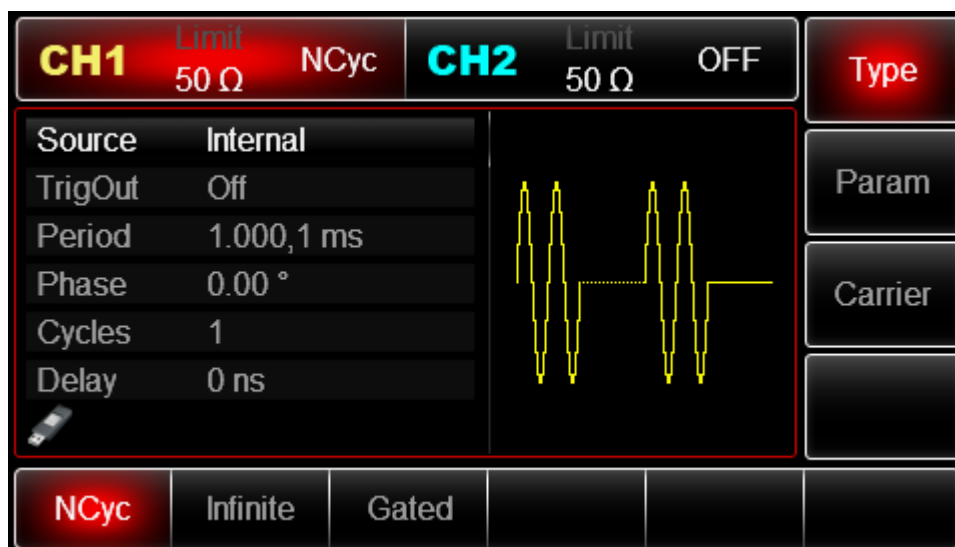

### 3.3.3 Gating mode

Press soft function keys **Type** → **Gated** successively on the interface to enter gating mode. In mode of gating pulse train, trigger source, trigger output, trigger edge, burst period (period of pulse train) and recurring number will be automatically hidden in parameter list. As only external trigger source can be used, waveform generator is triggered according to hardware of external digital modulation interface (FSK Trig connector) of back panel. When polarity is positive and trigger input signal is at high level, a continuous waveform is output; when trigger input signal is at low level, the current waveform period is finished first and then stop at the level corresponding to initial phase of the waveform selected. For noise waveform, when gated signal is spurious, output will be immediately stopped. Polarity can be changed with multi-functional knob and direction key on the interface for selecting gating mode (as shown in the figure below) or by pressing soft key **Param** → **Polarity**.

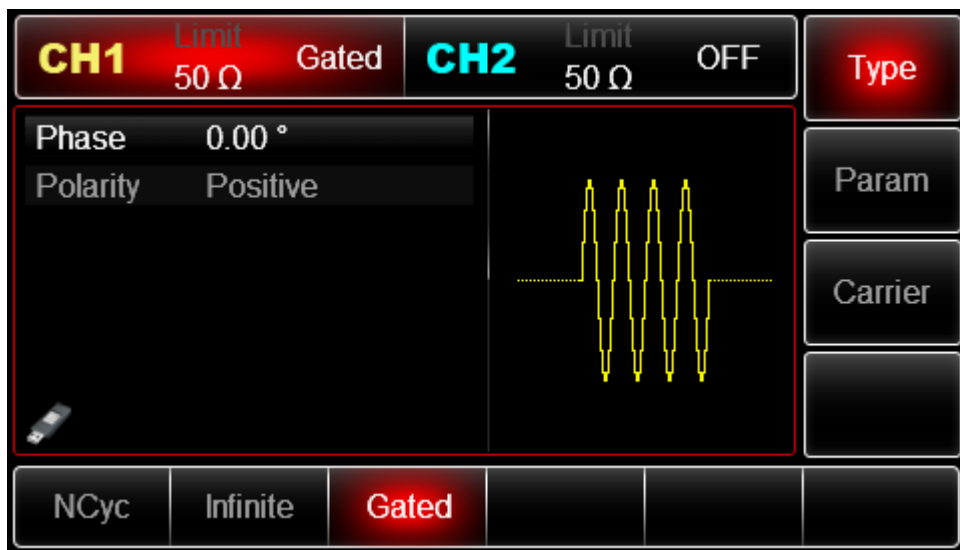
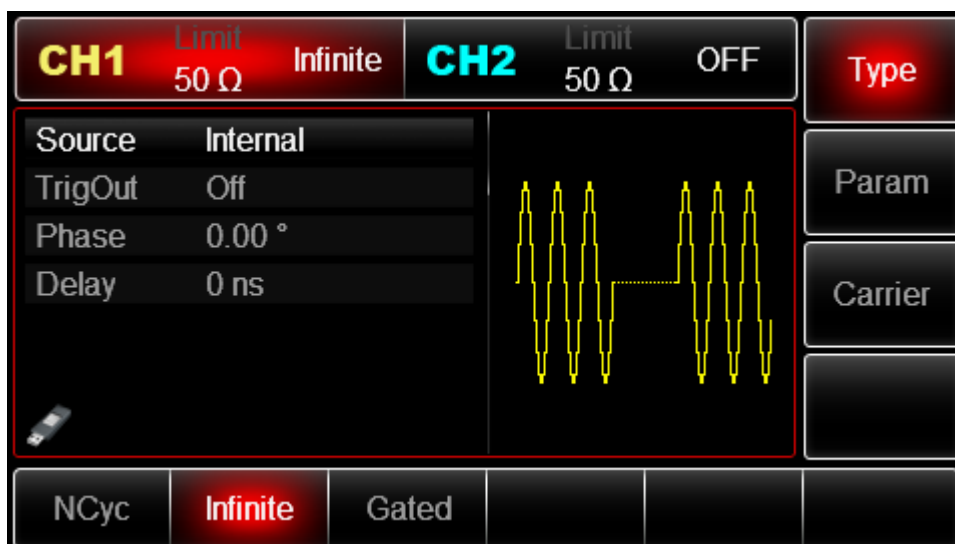

Figure 3 -49 Select gating mode

#### Infinite mode

Press soft function keys **Type** → **Infinite** successively on the interface for starting pulse function to enter infinite mode. In mode of infinite pulse train, burst period (period of pulse train) and recurring number will be automatically hidden in parameter list. Infinite pulse train amounts to infinite cycle index of waveform. The signal generator outputs continuous waveform when receiving trigger signal. The trigger source of pulse train can be internal, external or manual in this mode. To change it, you can use multi-functional knob and direction key on the interface for selecting type of pulse train (as shown in the figure below) or press soft function key **Param** → **Source**



### 3.3.4 Phase of Burst

Phase of pulse train is phase at starting point of pulse train. It is in the range of  $0^{\circ}\sim+360^{\circ}$ . The default initial phase is  $0^{\circ}$ . To change it, you can use multi-functional knob and direction key on the interface for selecting type of pulse train or press soft function key

**Param** → **Phase**.

- For sine wave, square wave, ramp wave and pulse wave,  $0^{\circ}$  is the point at which the waveform passes 0V (or DC offset value) in forward direction.
- For arbitrary waveform,  $0^{\circ}$  is the first waveform point downloaded to the storage.
- Initial phase has no effect on the noise wave.

### 3.3.5 Period of Burst

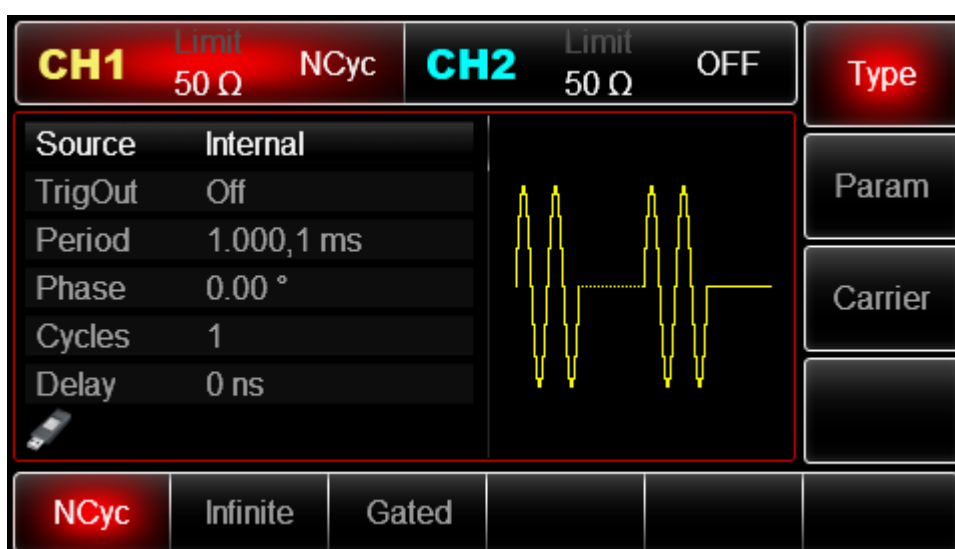

Figure 3 -51 Set period of pulse train

Burst period (period of pulse train) is only applicable to N cycle mode, and is defined as the time from one pulse train to the next pulse train. When trigger source is external or manual, burst period

(period of pulse train) will be hidden in parameter list. The range of burst period (period of pulse train) is  $1\mu\text{s}\sim 500\text{s}$ ; the default "burst period" is 1ms. To change it, you can use multi-functional knob and direction key or press soft key **Param** → **Period** after selecting type of pulse train as N cycle.

- Burst period (period of pulse train)  $\geq$  waveform period  $\times$  recurring number (number of pulse trains). The waveform period is reciprocal of waveform frequency mentioned in "select pulse train".
- If burst period (period of pulse train) is too short, signal generator will automatically increase the period to allow output of a designated number of cycles.

### 3.3.6 Counting of Burst

In N cycle mode, counting of pulse train is used to designate the number of waveform cycles. It is in the range of  $1\sim 1000000$  periods and 1 by default. To change it, you can use multi-functional knob and direction or press soft function key **Param** → **Cycles** after selecting type of pulse train as "N cycle".

- Recurring number  $\leq$  burst period  $\times$  waveform frequency
- If recurring number exceeds the above limit, signal generator will automatically increase period of pulse train to adapt to the designated counting of pulse train (without changing waveform frequency).

### 3.3.7 Select Trigger Source

The signal generator generates output of pulse train upon receiving a trigger signal, and then waits for the next trigger signal. The trigger source of pulse train can be internal, external or manual. To change it, you can use multi-functional knob and direction key on the interface for selecting type of pulse train or press soft key **Param** → **Source**.

- 1) In case of internal trigger, pulse train is output continuously with designated frequency. The frequency of pulse train output is determined by period of pulse train. The signal generator can output "N cycle" or "infinite" pulse train.
- 2) In case of external trigger, waveform generator will accept a hardware trigger that has been applied to external digital modulation interface (FSK Trig connector) of back panel. The waveform generator will output a pulse train upon receiving a TTL pulse with designated polarity. The signal generator can output "N cycle", "gating" or "infinite" pulse train.
- 3) In case of manual trigger, backlight of Trigger on front panel flashes. A pulse train is output upon pressing Trigger. The signal generator can output "N cycle" or "infinite" pulse train.

### 3.3.8 Trigger Output

In case of internal or manual trigger source, the trigger signal (square wave) can be output through sync output interface. The signal is compatible with TTL level.

Default status of trigger output: off; if you need to change press **Param** → **TrigOut** → **On**

- Inner trigger: the instrument outputs a square wave with 50% duty ration from the beginning of pulse train. The period equals to that of specified pulse train.

- Manual trigger: the instrument outputs pulse with over 1us pulse width from the beginning of pulse train.
- External trigger: the menu will hide the trigger output option which is enabled by external modulation connector (FSK Trig connector). This connector should not be used as external and internal at the same time.

### 3.3.9 Trigger Edge

Trigger edge can be designated when external digital modulation interface (FSK Trig connector) is used as input. When it is used as input (i.e. internal trigger source), “rising edge” means that rising edge of external signal triggers output of a pulse train, and “falling edge” means that falling edge of external signal triggers output of a pulse train. In gating mode, when polarity in parameter list is “positive”, external signal triggers output of a pulse train at high level, and “negative polarity” means that external signal triggers output of a pulse train at low level. When it is used as output (i.e. “internal” or “manual” trigger and trigger output is “ON”), the default edge is “rising edge”. If you need to change, press

**Param** → **TrigEdge** → **Fall** (Gating mode: press **Param** → **Polarity** → **Negative** )

Comprehensive Example

First make the instrument run in pulse train mode, and then set a sine wave signal with period of 5ms and amplitude of 500mVpp as waveform of pulse train, set type of pulse train to be N-cycle, period of pulse train to be 15ms and recurring number to be 2. The specific steps are as follows:

Use pulse train function

Press **Menu** → **Burst** → **Type** → **NCyc** successively (press soft key **Type** to select if **Type** is not highlighted) to set type of pulse train to be “N-cycle” mode.

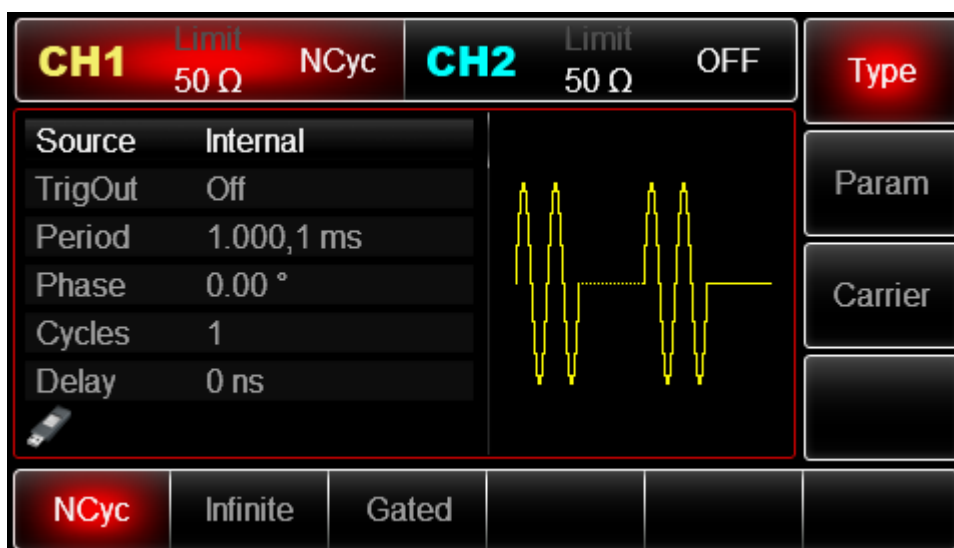

Figure 3 - 52 Set N cycle function

Select waveform of Burst

After setting N-cycle mode of pulse train, press **Carrier** → **Type** → **Sine** to select carrier signal as sine wave. The default waveform of pulse train is sine wave, so it is unnecessary to change in this example.

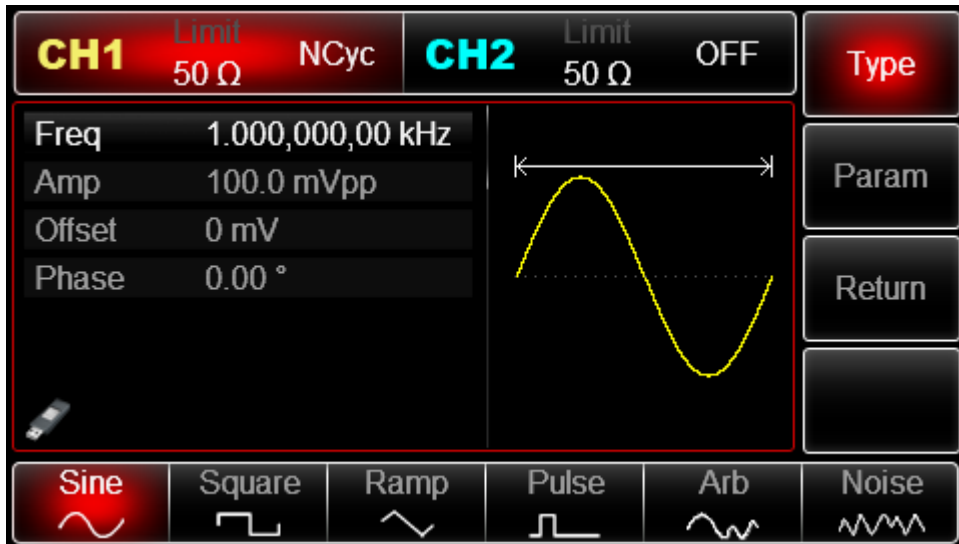

Figure 3 -53 Select waveform of pulse train

You can set amplitude with multi-functional knob and direction key (note: if frequency is displayed, only frequency can be set, which means that conversion between frequency and period cannot be realized. If frequency is displayed, period of 2ms is corresponding to frequency of 500Hz. They are reciprocal, i.e.  $T=1/f$ ). You can also press soft function key **Param** → **Freq** → **Freq** again (press the soft key **Freq** twice for conversion between frequency and period in parameter list), when the interface below will pop up. To set some parameter, press corresponding soft key, input the required value and select the unit.

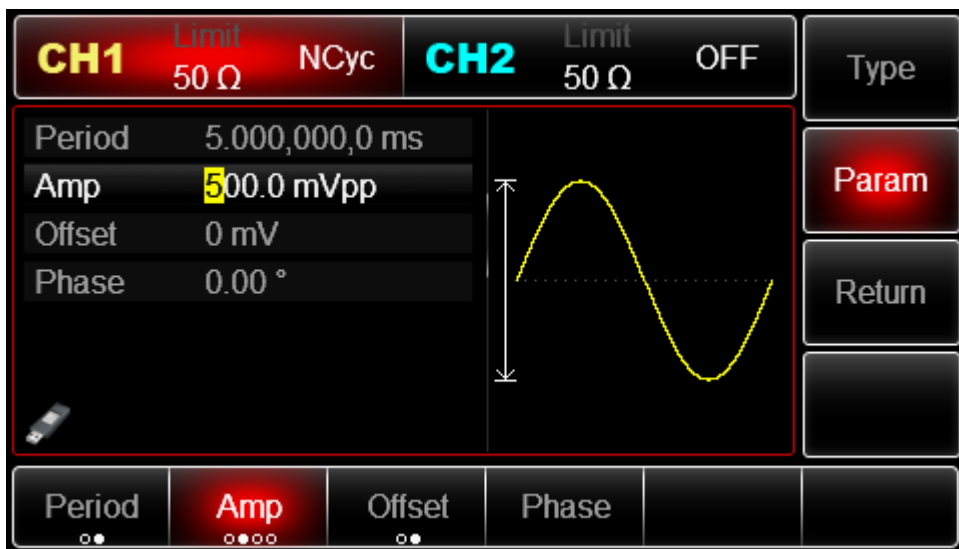

Figure 3 -54 Set waveform amplitude

Set period of pulse train and recurring number of waveform  
 Press soft function key **RETURN** to return to the interface below after selecting waveform of pulse train and relevant parameters:

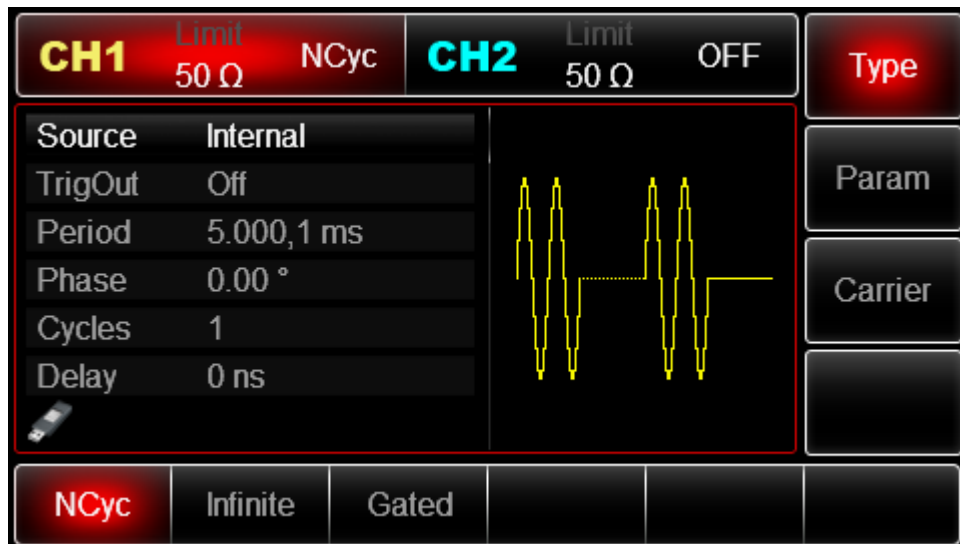

Figure 3 - 55 Set pulse train parameters

You can set with multi-functional knob and direction key. You can also press corresponding soft keys of parameters again, when the interface below will pop up. To set some parameter, press corresponding soft key, input the required value and select the unit.

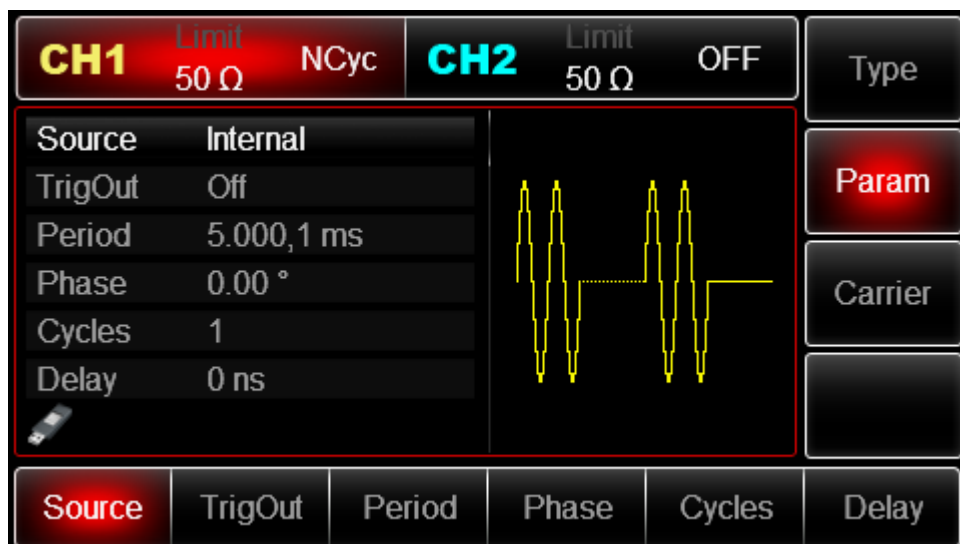

Figure 3 - 56 Set period of pulse train

Enable channel output

Press **CH1** button start channel 1 output quickly. Or enable output by pressing **Utility** and then **CH1 Setting**. After channel output is opened, backlight of **CH1** button is on, and on the right side of channel information label, the font "OFF" changes to "Ncyc", meaning open channel output.

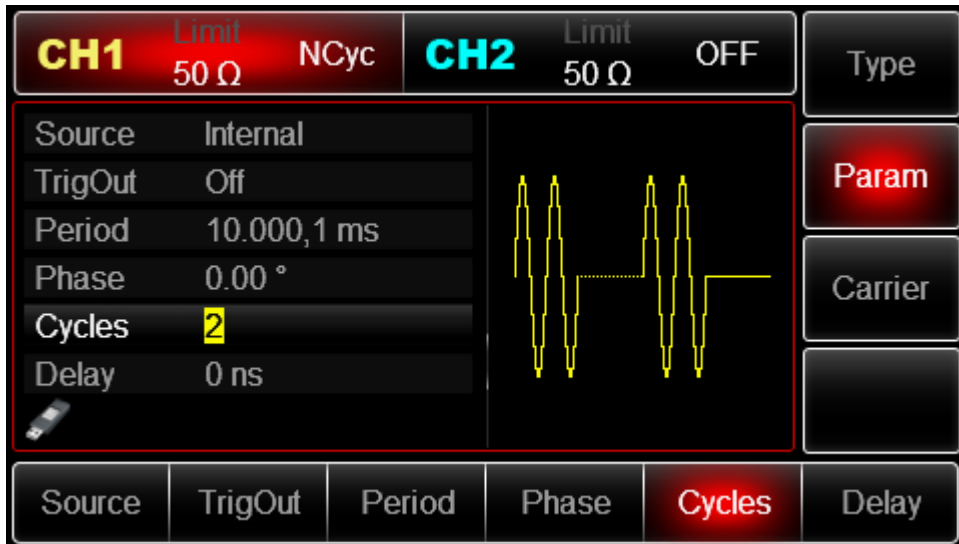

Figure 3 - 57 Use channel output

Check the shape of pulse train through oscilloscope, which is shown in the figure below:

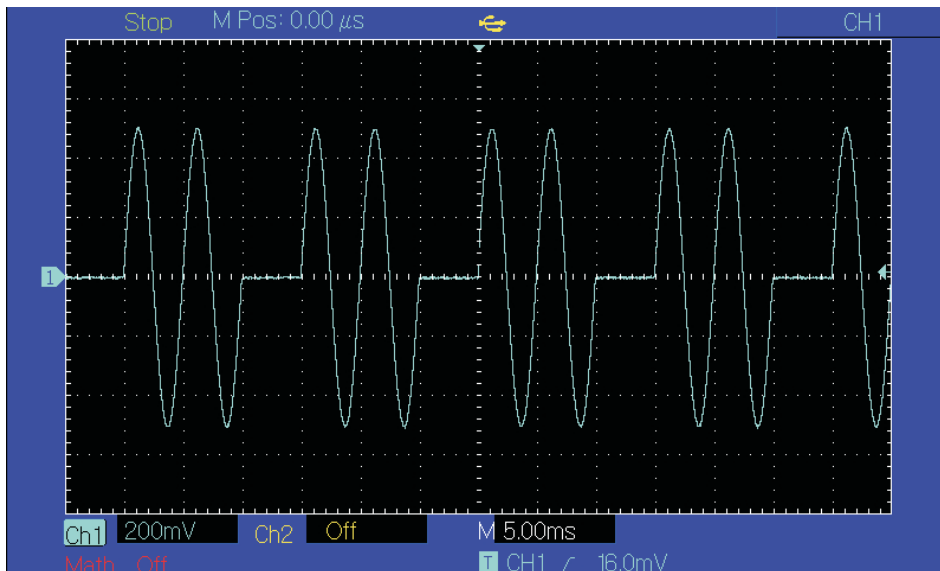

Figure 3 -58 Observe BURST waveform with oscilloscope

### 3.4 Output Arbitrary Wave

UTG2000B stores 160 types of standard waveform in nonvolatile storage. See Table 3 -4 (list of built-in arbitrary wave) for the name of waveform. The instrument creates and edits arbitrary waveform through upper computer software, and reads arbitrary waveform data file stored in U disk through USB interface of front panel.

#### 3.4.1 Use Arbitrary Wave Function

Press **Menu** → **Wave** → **Type** → **Arb** to use arbitrary wave function. After the function is used, UTG2000B function/arbitrary waveform generator will output arbitrary waveform with the current setting.

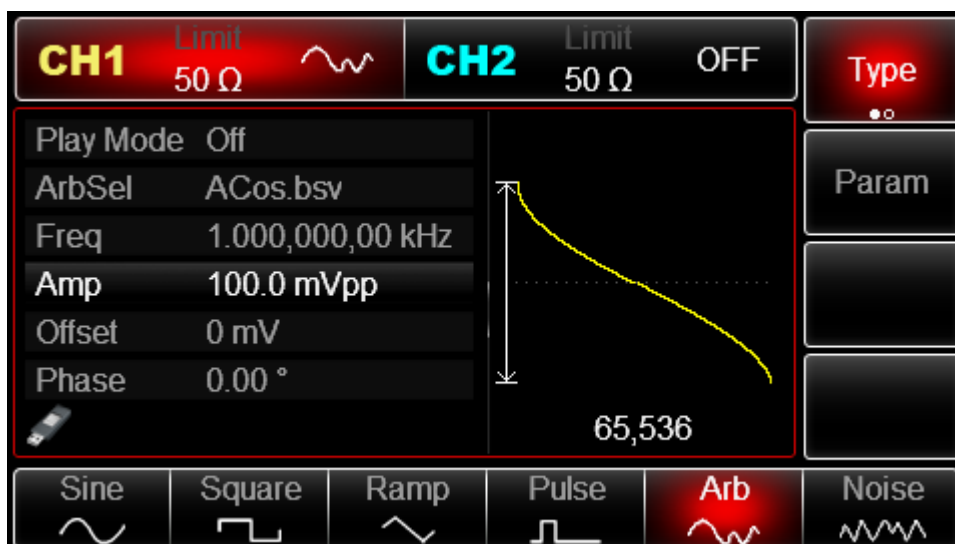

Figure 3 -59 Select Arb function

### 3.4.2 Point-by-point Output/Play Mode

UTG2000B supports point-by-point output of arbitrary waveform. In point-by-point output mode, signal generator automatically calculates frequency of output signal (4882.81250Hz) according to waveform length (e.g. 65536 points) and sampling rate. The signal generator outputs waveform points one by one with this frequency. Point-by-point output mode can prevent loss of important waveform point. The default is “No”. In such case, arbitrary waveform is output with fixed length (8,192 points) and frequency in parameter list through automatic interpolation of software or test count. To change it, you can use multi-functional knob and direction key on the interface for using arbitrary wave function or press

**Param** → **PlayMode**. When play mode is “ON”, frequency and phase will be displayed in parameter list.



Figure 3 -60 Set point-by-point output function

### 3.4.3 Select Arbitrary Wave

UTG2000B allows users to output arbitrary waveform in internal or external storage of the instrument. You can select the arbitrary wave you need with multi-functional knob and direction key on the interface for using arbitrary wave function or by pressing soft keys

**Param** → **ArbSel** successively.

Note: use multi-functional knob and direction key or press soft keys **Param** → **ArbSel** successively to select storage after inserting U disk into USB interface of front panel, and then select the arbitrary waveform you need. UTG2000B supports \*.csv or \*.bsv files with waveform less than 16M points long.

Table 3 - 6 List of built-in arbitrary wave

Type	Name	Description
Common (15 types)	Sin	Sine function
	Square	Square wave
	Ramp	Ramp wave
	NegRamp	Negative ramp wave
	PPulse	Positive pulse
	NPulse	Negative pulse
	Noise	Noise wave
	Sinc	Sinc function
	Cardiac	Electrocardiography
	EEG	Electroencephalogram
	DualTone	Dual tone signal
	AbsSine	Absolute sine value
	StairDn	Stair down
	StairUp	Stair up
	Trapezia	Trapezia
Engine (25 types)	BandLimited	Band-limited signal
	BlaseiWave	Blasting vibration "time-vibration velocity"curve
	Butterworth	Butterworth filter
	Chebyshev1	Type I Chebyshev filter
	Chebyshev2	Type II Chebyshev filter
	Combin	Composite function
	CPulse	C-Pulse signal
	CWPulse	CW pulse signal
	DampedOsc	Damped oscillation "time-displacement"curve
	DualTone	Dual tone signal
	Gamma	Gamma signal
	GateVibar	Gate self-oscillation signal
	LFMPulse	Linear frequency modulation pulse signal
	MCNoise	Mechanical construction noise
	Discharge	Discharge curve of NI-MH battery
	Pahcur	Current waveform of brushless DC motor
	Quake	Seismic wave
	Radar	Radar signal
Ripple	Power ripple	

	RoundHalf	Hemispheric wave	
	RoundsPM	RoundsPM waveform	
	StepResp	Step response signal	
	SwingOsc	Swing oscillation function- time curve	
	TV	TV signal	
	Voice	Voice signal	
Maths (27 types)	Airy	Airy function	
	Besselj	Class-I Bessel function	
	Besselk	Besselk function	
	Bessely	Class-II Bessel function	
	Cauchy	Cauchy distribution	
	Cubic	Cubic function	
	Dirichlet	Dirichlet function	
	Erf	Error function	
	Erfc	Complementary error function	
	ErfcInv	Inverse complementary error function	
	ErfInv	Inverse error function	
	ExpFall	Exponential falling function	
	ExpRise	Exponential rising function	
	GammaLn	Natural logarithm of Gamma function	
	Gauss	Gaussian distribution or normal distribution	
	HaverSine	Haversine function	
	Laguerre	Quartic Laguerre polynomial	
	Laplace	Laplace distribution	
	Legend	Quintic Legendre polynomial	
	Log	Denary logarithmic function	
	LogNormal	Logarithmic normal distribution	
	Lorentz	Lorentzian function	
	Maxwell	Maxwell distribution	
		Rayleigh	Rayleigh distribution
		Versiera	Versiera
		Weibull	Weibull distribution
		ARB_X2	Square function
SectMod (5types)	AM	Sectioned amplitude modulation wave of sine	
	FM	Sectioned frequency modulation wave of sine	
	PFM	Sectioned frequency modulation wave of pulse	
	PM	Sectioned phase modulation wave of sine	
	PWM	Sectioned frequency modulation wave of pulse width	
Bioelect (6 types)	Cardiac	Electrocardiosignal	
	EOG	Electro-oculogram	
	EEG	Electroencephalogram	
	EMG	Electromyogram	
	Pulseilogram	Pulsilogram of common people	
	ResSpeed	Respiratory speed curve of common people	
Medical (4	LFPulse	Low-frequency pulse electrotherapy waveform	
	Tens1	Transcutaneous electric nerve stimulation waveform 1	
	Tens2	Transcutaneous electric nerve stimulation waveform 2	

types)	Tens3	Transcutaneous electric nerve stimulation waveform 3
Standard (17 types)	Ignition	Ignition waveform of automobile internal-combustion engine
	ISO16750-2 SP	Automobile starting sectional drawing with oscillation
	ISO16750-2 Starting1	Automobile voltage waveform caused by start-up 1
	ISO16750-2 Starting2	Automobile voltage waveform caused by start-up 2
	ISO16750-2 Starting3	Automobile voltage waveform caused by start-up 3
	ISO16750-2 Starting4	Automobile voltage waveform caused by start-up 4
	ISO16750-2 VR	Sectional drawing of automobile working voltage in resetting
	ISO7637-2 TP1	Transient phenomena of automobile caused by power cut
	ISO7637-2 TP2A	Transient phenomena of automobile caused by inductance in wiring
	ISO7637-2 TP2B	Transient phenomena of automobile caused by turning off start-up changer
Standard (17 types)	ISO7637-2 TP3A	Transient phenomena of automobile caused by conversion
	ISO7637-2 TP3B	Transient phenomena of automobile caused by conversion
	ISO7637-2 TP4	Working sectional drawing of automobile in start-up
	ISO7637-2 TP5A	Transient phenomena of automobile caused by power cut of battery
	ISO7637-2 TP5B	Transient phenomena of automobile caused by power cut of battery
	SCR	SCR sintering temperature release drawing
	Surge	Surge signal
Trigonometric function Trigonome (21 types)	CosH	Hyperbolic cosine
	CosInt	Cosine integral
	Cot	Cotangent function
	CotHCon	Concave hyperbolic cotangent
	CotHPro	Convex hyperbolic cotangent
	CscCon	Concave cosecant
	CscPro	Convex cosecant
	CotH	Hyperbolic cotangent
	CscHCon	Concave hyperbolic cosecant
	CscHPro	Convex hyperbolic cosecant
	RecipCon	Concave reciprocal
	RecipPro	Convex reciprocal
	SecCon	Concave secant
	SecPro	Concave secant
	SecH	Hyperbolic secant
	Sinc	Sinc function
	SinH	Hyperbolic sine
	SinInt	Sine integral
	Sqrt	Square root function
	Tan	Tangent function

	TanH	Hyperbolic tangent
AntiTrigonome (17 types)	Acos	Arc-cosine function
	ACosH	Arc- hyperbolic cosine function
	ACotCon	Concave arc cotangent function
	ACotPro	Convex arc cotangent function
	ACotHCon	Concave arc- hyperbolic cosine function
	ACotHPro	Convex arc- hyperbolic cosine function
	ACscCon	Concave arc cosecant function
	ACscPro	Convex arc cosecant function
	ACscHCon	Concave arc hyperbolic cosecant function
	ACscHPro	Convex arc hyperbolic cosecant function
	ASecCon	Concave arc secant function
	ASecPro	Convex arc secant function
	ASecH	Arc hyperbolic secant function
	ASin	Arcsin function
	ASinH	Arc hyperbolic sine function
	ATan	Arctan function
	ATanH	Arc hyperbolic tangent function
Window function Window (17 types)	Bartlett	Bartlett window
	BarthannWin	Corrected Bartlett window
	Blackman	Blackman window
	BlackmanH	BlackmanH window
	BohmanWin	BohmanWin window
	Boxcar	Rectangular window
	ChebWin	Chebyshev window
	GaussWin	Gaussian window
	FlattopWin	Flat-top window
	Hamming	Hamming window
	Hanning	Hanning window
	Kaiser	Kaiser window
	NuttallWin	Minimum four-item Blackman-Harris window
	ParzenWin	Parzen window
	TaylorWin	Taylor window
Triang	Triangle window, also Fejer window	
TukeyWin	Tukey window	
Complex Wavelets (7 types)	Complex Frequency	Complex Frequency B-spline function
	Complex Gaussian	Complex Gaussian function
	Complex Morlet	Complex Morlet wavelet
	Complex Shannon	Complex Shannon function
	Mexican hat	Mexican hat wavelet
	Meyer	Meyer wavelet
	Morlet	Morlet wavelet

### **3.4.4 Create and Edit Arbitrary Waveform**

UTG2000B creates and edits complicated arbitrary waveform (of any amplitude and shape) through powerful upper computer software. Please see Operation Manual of UTG2000B Arbitrary Waveform Editing Software for specific operation.

---

# Chapter 4 Fault Handling

Possible faults in use of UTG2000B and troubleshooting methods are listed below. If these faults occur, please handle them according to corresponding steps. If they cannot be handled, please contact with the dealer or local office, and provide the information about your machine (method: press Utility → System → About successively).

## 4.1 No Display on Screen (Blank Screen)

If the signal generator still does not display after pressing power switch on front panel

- 1) Inspect whether power source is connected well.
- 2) Inspect whether power switch on back panel is connected well at "I".
- 3) Whether power switch on front panel is connected well.
- 4) Restart the instrument.
- 5) If the product still cannot be used normally, please contact with the dealer or local office and let us serve you.

## 4.2 No Waveform Output

Setting is correct but no waveform is output

- 1) Inspect whether BNC cable and channel output terminal are connected correctly.
- 2) Inspect whether CH1 or CH2 is turned on.
- 3) If the product still cannot be used normally, please contact with the dealer or local office and let us serve you.

## 4.3 Fail to Correctly Recognize U Disk

- 1) Inspect whether U disk works normally.
- 2) Ensure that Flash U disk is used. The instrument does not support hard disk.
- 3) Restart the instrument, and insert U disk again to see whether it works normally.
- 4) If U disk still cannot be correctly recognized, please contact with the dealer or local office and let us serve you.

# Chapter 5 Service and Support

## 5.1 Program Upgrade of Product

Users upgrade the current program of function/arbitrary waveform generator with built-in program upgrade system after getting program upgrade package through Market Department or website of UNI-T to ensure that the program of function /arbitrary waveform generator is the latest version released by UNI-T.

1. Own a UTG2000B function /arbitrary waveform generator of UNI-T, and get model, hardware and software version by pressing soft keys **Utility** → **System** → **About** successively.
2. Get program file and supporting file of upgrade of model the same as that of function/arbitrary waveform generator to be upgraded through website or Market Department of UNI-T, and upgrade according to steps in the supporting file.

## 5.2 Outline of Warranty

UNI-T (Uni-Trend Technology (China) Limited) guarantees that the products it produces and sells are free from any defects of material and process within 3 years from authorizing the dealer to deliver them. If the product is proven to be defective during warranty period, UNI-T will repair and replace according to provisions of warranty.

To arrange repair or ask for the whole warranty, please contact with the nearest sales or maintenance department of UNI-T.

Except warranties provided in the outline or other applicable warranties, UNI-T does not provide any other express or implied warranties, including but not limited to any implied warranties about tradability and applicability to special purpose of the product. In any case, UNI-T assumes no responsibility for indirect, special or consequent loss.

## 5.3 Contact Us

You can directly contact with Uni-Trend Technology (China) Limited (UNI-T, Inc.) in mainland China if you have any inconvenience in use of the product:

Beijing time 8:00 -17:30, Monday-Friday or e-mail us. Our e-mail address: [infosh@uni-trend.com.cn](mailto:infosh@uni-trend.com.cn)

Please contact with local dealer or sales center of UNI-T for products outside the mainland China.

Service support, many products of UNI-T are equipped with plans for extending warranty period and calibration period. Please contact with local dealer or sales center of UNI-T. Please visit our website to get list of addresses of service centers in various regions.

Website: <http://www.uni-trend.com>

# Appendix A: Factory Reset State

Parameter	Factory default
Channel parameter	
Current carrier wave	Sine wave
Output load	50Ω
Sync output	Channel 1
Channel output	Off
Channel output opposition	Off
Amplitude limit	Off
Upper amplitude limit	+5V
Lower amplitude limit	-5V
Fundamental wave	
Frequency	1kHz
Amplitude	100mVpp
DC offset	0mV
Initial phase	0°
Duty ratio of square wave	50%
Degree of symmetry of ramp wave	100%
Duty ratio of pulse wave	50%
Rising edge of pulse wave	1μs
Falling edge of pulse wave	1μs
Arbitrary wave	
Built-in arbitrary wave	Acos
Play mode	No
AM modulation	
Modulation source	Internal
Modulation wave	Sine wave
Modulation frequency	100Hz
Modulation depth	100%
FM modulation	
Modulation source	Internal
Modulation wave	Sine wave
Modulation frequency	100Hz
Frequency deviation	1kHz
PM modulation	
Modulation source	Internal
Modulation wave	Sine wave
Modulation frequency	100Hz
Phase deviation	180°
PWM modulation	
Modulation source	Internal
Modulation wave	Pulse wave
Modulation frequency	100Hz
Deviation of duty ratio	20%
ASK modulation	
Modulation source	Internal
ASK rate	100Hz
FSK modulation	

Modulation source	Internal
FSK rate	100Hz
Hopping frequency	2MHz
PSK modulation	
Modulation source	Internal
PSK rate	100Hz
PSK phase	0°
BPSK modulation	
Carrier wave	Sine
Modulation source	PN7.PN9.PN11.PN15.PN17.PN21.PN23.PN25
Phase	0°
Phase 1	180°
Coding mode	PN15
BPSK rate	100Hz
QPSK modulation	
Carrier wave	Sine
Modulation source	PN7.PN9.PN11.PN15.PN17.PN21.PN23.PN25
QPSK rate	100Hz
Phase 1	0°
Phase 2	180°
Phase 3	270°
Phase 4	270°
OSK modulation	
Modulation source	Internal
Oscillation time	1ms
OSK rate	100Hz
DSBSSM modulation	
Modulation source	Internal
Modulation wave	Sine
modulation rate	100Hz
QAM modulation	
Constellation	4QAM
Coding mode	PN7
QAM rate	100Hz
SUM modulation	
Modulation source	Internal
Modulation wave	Sine
Modulation frequency	100Hz
Modulation depth	100%
Frequency sweep	
Type of frequency sweep	Linear
Initial frequency	1kHz
Stop frequency	2kHz
Frequency sweep time	1s
Trigger source	Internal
Trigger output	Off
Trigger edge	Rising edge
Pulse train	
Mode of pulse train	N cycle
Initial phase	0°

Burst period (period of pulse train)	1.0001ms
Recurring number	1
Gated polarity	Positive polarity
Trigger source	Internal
Trigger output	Off
Trigger edge	Rising edge
System parameter	
IP type	DHCP
Clock source	Internal
Clock output	Off
Sound of buzzer	On
Separator of numbers	,
Backlight	100%
Language *	Depend on factory setting

# Appendix B: Performance Index

Model	UTG2122B	UTG2082B	UTG2062B
Channel	Dual channel		
Max frequency	120MHz	80MHz	60MHz
Sampling rate	1.28GSa/s (320MSa/s ,4 times interpolation)		
Waveform	Sine, square, ramp, burst, noise, DC, arbitrary, harmonic, expression		
Working modes	Output gating, continuous, modulation, frequency sweep, burst		
Modulation types	AM, FM, PM, ASK, FSK, PSK, BPSK, QPSK, OSK, SUM, DSBAM, QAM, PWM		
Frequency characteristic			
Sine wave			
frequency range	1 $\mu$ Hz~120MHz	1uHz~80MHz	1uHz~60MHz
resolution	1uHz		
Accuracy	$\pm 0.5$ ppm, 25 $^{\circ}$ C		
	Annual aging rate $\pm 1$ ppm		
harmonic distortion (typical value)	test condition: output frequency 0dBm		
	DC~1MHz	-60dBc	
	1MHz ~10MHz	-55dBc	
	10MHz ~40MHz	-50dBc	
	40MHz ~80MHz	-45dBc	
	80MHz ~120MHz	-40dBc	
THD (typical value)	<0.2%(DC~20kHz,1Vpp)		
Spurious signal(anharmonic)	test condition: output frequency 0dBm		
	DC~10MHz,<-70dBc		
Phase noise(typical)	> 10MHz <-70dBc+6dB/ octave 10 MHz : $\leq -125$ dBc/Hz(typical,0dBm,10kHz deviation)		
Square wave			
frequency range	1 $\mu$ Hz~30MHz	1 $\mu$ Hz~25MHz	1 $\mu$ Hz~25MHz
resolution	1uHz		
rise/fall time (typical,1kHz,1Vpp)	<11ns	<12ns	<13ns
overshoot	<2% (typical)		
Duty ratio	0.001%~99.999% (limited by current frequency, output		
symmetry (duty ratio=50%)	1% of period + 4ns		
Shake	typical(1MHz,1Vpp,50 $\Omega$ ) $\leq 5$ MHz: 2ppm + 200ps,>5MHz: 200ps		
Ramp wave			
Frequency	1 $\mu$ Hz~5MHz	1 $\mu$ Hz~4MHz	1 $\mu$ Hz~3MHz
resolution	1uHz		
nonlinearity	< 1% of peak output(typical value,1kHz,1Vpp ,symmetry 100%)		

Symmetry	0.0% ~ 100.0%		
Impulse wave			
Frequency	1μHz~30MHz	1μHz~25MHz	1μHz~25MHz
resolution	1uHz		
pulse width	≥16ns		
variable edge	7ns~10s	8ns~10s	9ns~10s
overshoot	<2% (typical 1Vpp)		
shake	150ps		
Gauss noise			
Bandwidth	120MHz(-3dB)(typical)	80MHz(-3dB)(typical)	60MHz(-3dB)(typical)
DC offset	± 5V(50Ω)		
range(peak AC+DC)	±10V (high resistance)		
offset accuracy	±(1%+2mV)		
Arbitrary wave			
Frequency	1μHz~25MHz	1μHz~20MHz	1μHz~15MHz
resolution	1uHz		
Wave length	8pts~16Mpts		
vertical resolution	16bits(symbol included)		
Sampling rage	1.28GS/s(interpolation),320MS/s (DDS mode)		
Typical value of minimum rising/falling time (typical value)	< 5ns	< 6ns	< 7ns
Shake	150ps (play mode)		
Nonvolatile storage	160 waves		
Output			
amplitude	≤20MHz : 1mVpp~10Vpp;(50Ω) ≤60MHz: 1mVpp~5Vpp;(50Ω) ≤120MHz: 1mVpp~2Vpp;(50Ω)		
	≤20MHz : 2mVpp~20Vpp;( high resistance) ≤60MHz: 2mVpp~10Vpp;( high resistance) ≤120MHz: 2mVpp~4Vpp;( high resistance)		
accuracy(1kHz	±(1% of set value+1mVpp)		
sine wave)	test condition : typical value (sine wave,2.0Vpp)		
amplitude flatness (equal to 1kHz sine wave,1Vpp/50Ω)	≤10MHz : ±0.1dB		
	≤60MHz : ±0.2dB		
	≤80MHz : ±0.4dB		
	≤120MHz : ±0.8dB		
waveform output			
impedance	50Ω typical value		
Insulation	Maximum 42Vpk to ground wire		
Protection	channel protection		
Modulation types			
AM			
Carrier wave	Sine wave, square wave(1μHz~30MHz), ramp wave, arbitrary wave		
Source	Internal/external		
modulation wave	Sine wave, square wave, ramp wave, noise, arbitrary wave		

modulation frequency	2mHz~1MHz		
Modulation depth	0%~120%		
FM			
Carrier wave	Sine wave, square wave(1μHz~30MHz), ramp wave, arbitrary wave		
Source	Internal/external		
Modulation wave	Sine wave, square wave, ramp wave, noise, arbitrary wave		
Modulation frequency	2mHz~1MHz		
Frequency deviation	DC ~60MHz	DC ~40MHz	DC ~30MHz
PM			
Carrier wave	Sine wave, square wave(1μHz~30MHz), ramp wave, arbitrary wave		
Source	Internal/external		
Modulation wave	Sine wave, square wave, ramp wave, noise, arbitrary wave		
Modulation frequency	2mHz~1MHz		
Phase deviation	0°~360°		
ASK			
Carrier wave	Sine wave, square wave(1μHz~30MHz), ramp wave, arbitrary wave		
Source	Internal/external		
Modulation wave	Square wave (Duty ratio 50%)		
Modulation frequency	2mHz~1MHz		
FSK			
Carrier wave	Sine wave, square wave(1μHz~30MHz), ramp wave, arbitrary wave		
Source	Internal/external		
Modulation wave	Square wave (Duty ratio 50%)		
Modulation frequency	2mHz~1MHz		
BPSK			
Carrier wave	Sine wave, square wave(1μHz~30MHz), ramp wave, arbitrary wave		
Source	Internal/external		
Modulation wave	Square wave (Duty ratio 50%)		
Modulation frequency	2mHz~1MHz		
QPSK			
Carrier wave	Sine wave, square wave(1μHz~30MHz), ramp wave, arbitrary wave		
Source	PN7,PN9,PN11,PN15,PN17,PN21,PN23,PN25		
Modulation wave	Square wave (Duty ratio 50%)		
Modulation frequency	2mHz ~ 1MHz		
OSK			
Carrier wave	Sine wave		
Source	Internal/external		
Oscillation time	8ns~200s		
Keying frequency	2mHz ~ 1MHz		
SUM			
Carrier wave	Sine wave, square wave(1μHz~30MHz), ramp wave, noise wave, arbitrary wave		
Source	Internal/external		

Modulation wave	Sine wave, square wave(1μHz~30MHz), ramp wave, noise wave, arbitrary wave
Modulation frequency	2mHz ~ 1MHz (internal) ; DC ~ 20kHz (external)
QAM	
QAM mode	QAM4, QAM8, QAM16, QAM32, QAM64, QAM128, QAM256 (built-in constellation modulation)
Modulation source	PN7, PN9, PN11, PN15, PN17, PN21, PN23, PN25
Chip rate	2mHz~1MHz
Amplitude	10mVpp~10Vpp(50Ω)
PWM	
Carrier wave	Pulse
Source	Internal/external
Modulation wave	Sine wave, square wave, ramp wave, noise, arbitrary wave
modulation frequency	2mHz ~ 1MHz
Width deviation	0%~49.99% of pulse width
Frequency sweep	
Carrier wave	Sine wave, square wave, ramp wave, arbitrary wave
Type	Linear or logarithmic
Frequency sweep time	1ms ~ 500s ± 0.1%
Trigger source	Manual, external or internal
Burst	
Waveform	Sine wave, square wave, ramp wave, pulse, noise and arbitrary wave
Type	Count(1~1,000,000 periods), infinite, gated
Initial and stop phase	0° ~ +360°
Internal cycle	1μs ~ 500 s ± 1%
Gated source	External trigger
Trigger source	Manual, external or internal
sync signal	
output level	TTL
output frequency	1μHz~10MHz
output frequency	50Ω, typical value
coupled mode	DC
rear panel connector	
External analog modulation input	± 5Vpk of full range
10MHz input/output frequency	>5kΩ input impedance
10MHz input/output level	10MHz ±50Hz
10MHz input/output impedance	TTL
locking time	10KΩ(input)/50Ω(output), typical value
locking time	<1s, typical value
External trigger	TTL

Trigger input	
Input level	TTL compatible
Slope	Rising or falling, optional
Pulse width	> 100 ns
Input impedance	> 10k $\Omega$ ,DC coupling
Response time	Frequency sweep : < 500 $\mu$ s,typical value
	Pulse train : < 500ns,typical value
Trigger output	
Level	TTL compatible
Pulse width	> 400ns,typical value
Output impedance	50 $\Omega$ ,typical value
Maximum frequency	1 MHz
Frequency meter	
Input level	TTL compatible
Range of input frequency	100mHz~200MHz
Accuracy	$\pm$ 51ppm
Frequency resolution	6 digit/s
coupled mode	DC
general technical specifications	
Display	
LCD	4.3 inches TFT
resolution	480 $\times$ 272
Power supply	
Power supply	100~240 VAC,45~440Hz,CAT II
Power consumption	Less than 50W
Fuse	2A,Class T,250V
Environment	
Temperature range	operating : 10 $^{\circ}$ C~+40 $^{\circ}$ C
	Non-operating : -20 $^{\circ}$ C~+60 $^{\circ}$ C
Cooling method	Forced fan cooling
Humidity range	Below +35 $^{\circ}$ C : $\leq$ 90% relative humidity
	+35 $^{\circ}$ C ~+40 $^{\circ}$ C $\leq$ 60%relative humidity
Altitude	Operating below 2,000m $^{\circ}$ C
	Non-operating below 15,000m
Mechanical specification	
Dimensions	305mm $\times$ 230mm $\times$ 93mm
Net weight	3.10kg
Rough weight	4.10kg

## Appendix C: List of Accessories

Model	UTG2000B(dual channel)
Standard configuration	A power line up to local standard
	A USB data line
	One BNC cables (1 m), One BNC+red and black alligator clip connection(1 m)
	A CD for users
	A product warranty card
	A user manual
Optional components	Power output module

# **Appendix D: Maintenance and Cleaning**

## **General maintenance**

- Please don't store or place the instrument where LCD is exposed to direct sunlight for a long time.
- To avoid damage to the instrument or connecting line, please don't place it in mist, liquid or solvent.

## **Cleaning**

- Please clean the instrument frequently in the light of use.
- Cut off the power, and then clean with soft cloth that is wet but not dripping (wipe floating dust off the exterior of instrument with mild detergent or clear water, don't use chemical medicine or detergent containing benzene, methylbenzene, dimethyl benzene, acetone and other potent substances).
- Please prevent scratch of LCD protection screen when cleaning instrument with LCD.
- Please protect the instrument against any corrosive liquid to prevent damage.

This user manual may be revised without prior notice

